

BOXER SERIES TRIMLESS

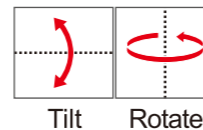
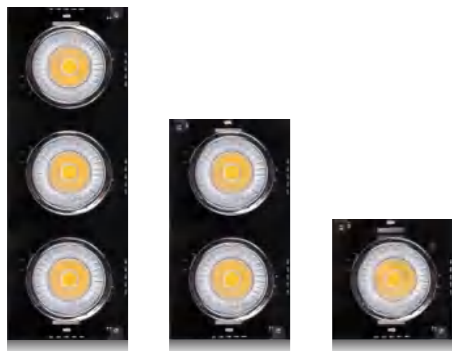

Product features

The Trimless BOXER Series is able to perform spot application or completely disappear into the ceiling as a downlight application. A dual application luminaires that offers accent lighting or serve as general Lighting. Their versatility enables their recessed luminaires to be used in all settings where general and accent lighting must be combined in the single luminaire. In this way the fitting blends with the space and has a great feeling of consistency. Trimless BOXER series are suitable for all kind's on indoor used application.

Range of Application

Commercial
Residential
Architectural
Hospitals
Industrial
Museum / Art gallery

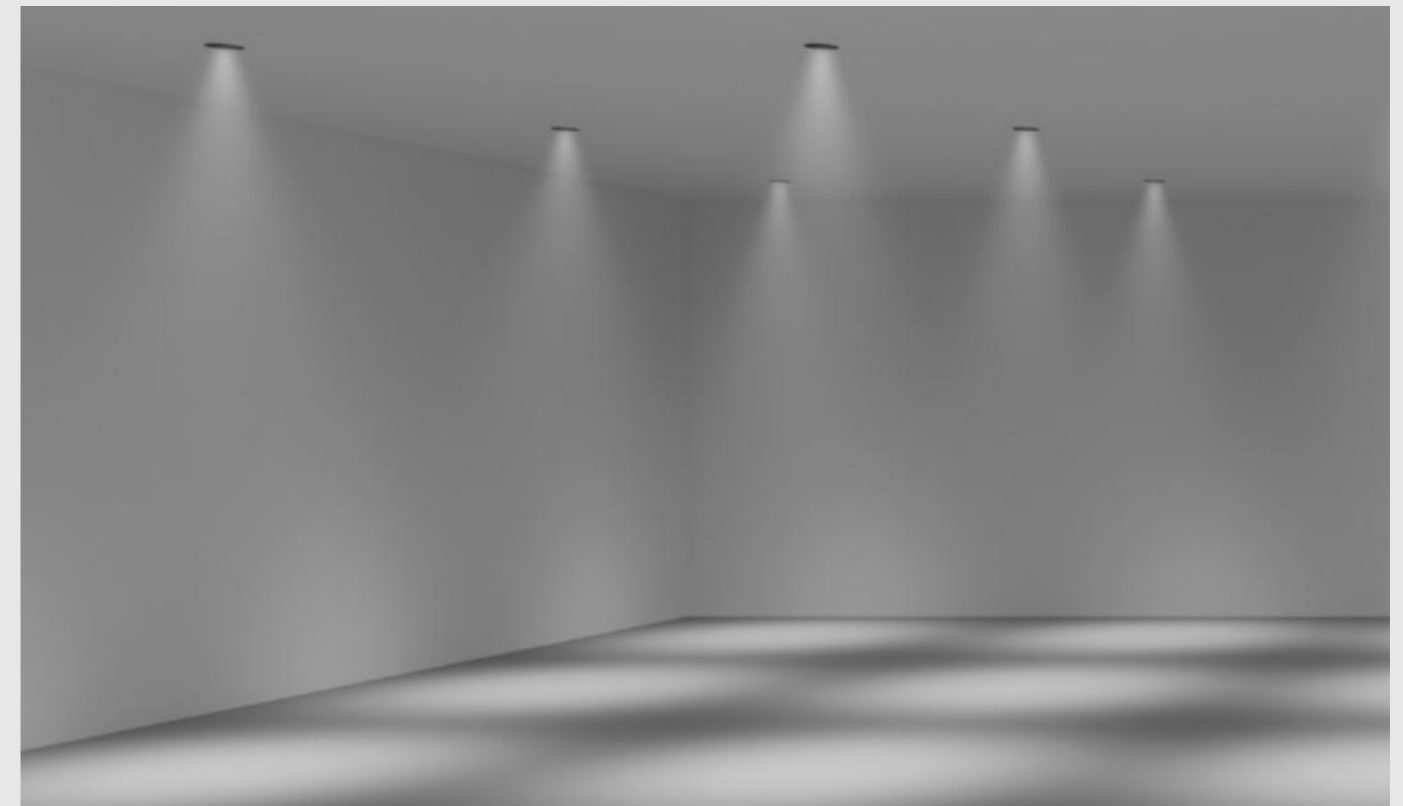

General lighting

Emphasis of objects or architectural elements.

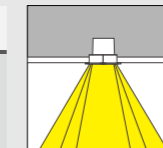
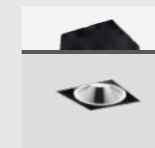

Downlights

Narrow to wide beam, Rotateally symmetrical light distribution for accent lighting.

LED

Wattage:16-38W
Lumen:1281-3147lm
Light distribution:
Narrow/Medium/Flood



General lighting

Emphasis of Multi objects or architectural elements.

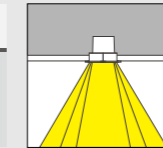

Downlights

Narrow to wide beam, Rotateally symmetrical light distribution for accent lighting.

LED

Wattage:2x16-2x38W
Lumen:2x1281-2x3147lm
Light distribution:
Narrow/Medium/Flood



General lighting

Emphasis of Multi objects or architectural elements.

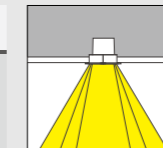
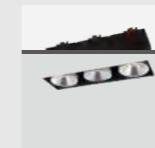

Downlights

Narrow to wide beam, Rotateally symmetrical light distribution for accent lighting.

LED

Wattage:3x16-3x38W
Lumen:3x1281-3x3147lm
Light distribution:
Narrow/Medium/Flood



Suitable for indoor use



Protection level is IP20



High efficiency Reflector



Comply with CE certification



The electrical grade is class2



CRI > 80 (standard)
CRI > 90 (optional)

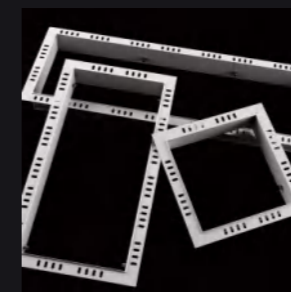

Reliable ceiling mounting system

Mounting spring system and integrated clip on the fixture enables secure, one-touch installation, eliminating the need of tightening screws. Best of all the process requires no additional parts, so you don't need to worry about losing anchors or clips.

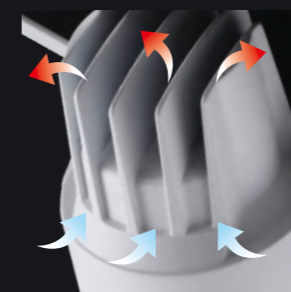

High efficiency dissipation heat sink

BOXER housing body construction serves as a cooling system designed to dissipate heat faster from the LED, also providing maximum air flow from the entire operation caused by rising hot air. When the operation temperature has been minimized the LEDs are guaranteed for their maximum life time and performance.



Interchangeable Socket System (ISS)

Simple solderless interchangeable socket system (ISS) that makes it possible for quick and easy maintenance of LED/COB modules. The ISS system is compatible with most popular brands COB such as Philips, Osram, Tridonic, Citizen & CREE. ISS has a special locking that makes it possible to add other accessories or secondary optics. Best of all installations are simple and extremely friendly to apply.

IO5 System(DARK LIGHTS)

Dark light VIPER downlight IO5 optical technology design with a light that is absolutely glare free by the human visual point. It's a top level of reflector technology that offers maximum visual comfort together with maximum light output.



BOXER SERIES SMALL ADJUSTABLE TRIMLESS PROJECTOR
LED MULTIPLE DOWNLIGHT

135

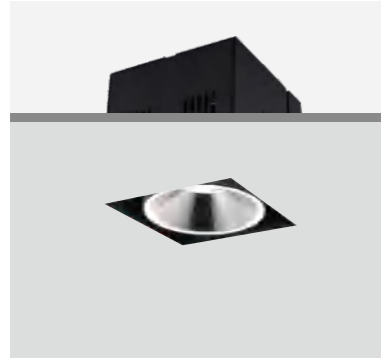

IP20 | CE | CB |

Trim: aluminium
Body: Die-cast aluminium
Housing: Steel
Optic: High efficiency Reflector
Weight: 0.65kg
CTN: 24PCS

IO5 INTERCHANGABLE OPTICAL SYSTEM See P.012

White Black Silver

Note: min 80mm(ceiling clearance)

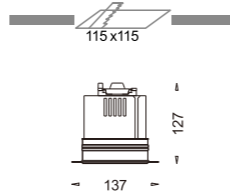

| ORDERING CODE | Power (W) | Beam Angle (°) | CCT (K) | Hot Lumen (Lm) | LOR (%) | UGR | On/Off | DRIVER 1-10V | DALI | Triac |
|--------------------|-----------|----------------|---------|----------------|---------|-----|--------|--------------|------|-------|
| 1FCOX800-W/B/S-830 | 16 | 20 | 3000 | 1281 | 82% | <19 | ✓ | ✓ | ✓ | ✓ |
| 1FCOX800-W/B/S-840 | | | 4000 | 1450 | | | | | | |
| 1FCOX800-W/B/S-850 | | | 5000 | 1480 | | | | | | |
| 1FCOX801-W/B/S-830 | 16 | 40 | 3000 | 1221 | 80% | <19 | ✓ | ✓ | ✓ | ✓ |
| 1FCOX801-W/B/S-840 | | | 4000 | 1415 | | | | | | |
| 1FCOX801-W/B/S-850 | | | 5000 | 1444 | | | | | | |
| 1FCOX802-W/B/S-830 | 16 | 55 | 3000 | 1191 | 78% | <19 | ✓ | ✓ | ✓ | ✓ |
| 1FCOX802-W/B/S-840 | | | 4000 | 1379 | | | | | | |
| 1FCOX802-W/B/S-850 | | | 5000 | 1407 | | | | | | |

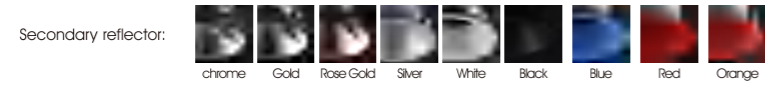
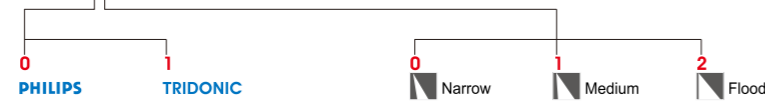

Optical accessories See P.012

PHILIPS SLM C 830 1203 L09 G1

3000K

| h(m) | E(lx) | D(mm) | h(m) | E(lx) | D(mm) | h(m) | E(lx) | D(mm) |
|------|-------|-------|------|-------|-------|------|-------|-------|
| 1.0 | 5056 | 380 | 1.0 | 2757 | 660 | 1.0 | 1790 | 940 |
| 2.0 | 1264 | 760 | 2.0 | 689 | 1310 | 2.0 | 447 | 1870 |
| 3.0 | 561 | 1140 | 3.0 | 306 | 1970 | 3.0 | 198 | 2810 |

BOXER SERIES SMALL ADJUSTABLE TRIMLESS PROJECTOR
LED MULTIPLE DOWNLIGHT

250X135



IP20 | CE | CB |

Trim: aluminium
Body: Die-cast aluminium
Housing: Steel
Optic: High efficiency Reflector
Weight: 1.16kg
CTN: 12PCS

IO5 INTERCHANGABLE OPTICAL SYSTEM See P.012

White Black Silver

Note: min 80mm(ceiling clearance)

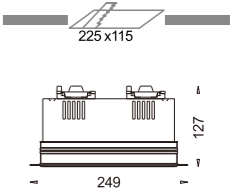

| ORDERING CODE | Power (W) | Beam Angle (°) | CCT (K) | Hot Lumen (Lm) | LOR (%) | UGR | On/Off | DRIVER 1-10V | DALI | Triac |
|--------------------|-----------|----------------|---------|----------------|---------|-----|--------|--------------|------|-------|
| 2FCOX800-W/B/S-830 | 2x16 | 20 | 3000 | 2x1281 | 82% | <19 | ✓ | ✓ | ✓ | ✓ |
| 2FCOX800-W/B/S-840 | | | 4000 | 2x1450 | | | | | | |
| 2FCOX800-W/B/S-850 | | | 5000 | 2x1480 | | | | | | |
| 2FCOX801-W/B/S-830 | 2x16 | 40 | 3000 | 2x1221 | 80% | <19 | ✓ | ✓ | ✓ | ✓ |
| 2FCOX801-W/B/S-840 | | | 4000 | 2x1415 | | | | | | |
| 2FCOX801-W/B/S-850 | | | 5000 | 2x1444 | | | | | | |
| 2FCOX802-W/B/S-830 | 2x16 | 55 | 3000 | 2x1191 | 78% | <19 | ✓ | ✓ | ✓ | ✓ |
| 2FCOX802-W/B/S-840 | | | 4000 | 2x1379 | | | | | | |
| 2FCOX802-W/B/S-850 | | | 5000 | 2x1407 | | | | | | |

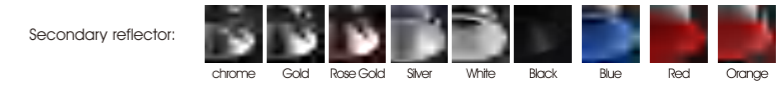
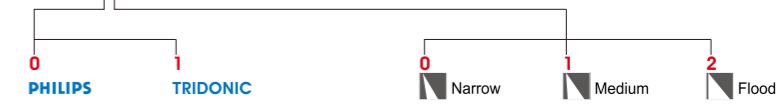

Optical accessories See P.012

PHILIPS SLM C 830 1203 L09 G1

3000K

| h(m) | E(lx) | D(mm) | h(m) | E(lx) | D(mm) | h(m) | E(lx) | D(mm) |
|------|-------|-------|------|-------|-------|------|-------|-------|
| 1.0 | 5056 | 380 | 1.0 | 2757 | 660 | 1.0 | 1790 | 940 |
| 2.0 | 1264 | 760 | 2.0 | 689 | 1310 | 2.0 | 447 | 1870 |
| 3.0 | 561 | 1140 | 3.0 | 306 | 1970 | 3.0 | 198 | 2810 |



BOXER SERIES SMALL ADJUSTABLE TRIMLESS PROJECTOR LED MULTIPLE DOWNLIGHT

360X135



IP20 | CE | CB |

Trim: aluminium
 Body: Die-cast aluminium
 Housing: Steel
 Optic: High efficiency Reflector
 Weight: 1.64kg
 CTN: 9PCS

Note: min 80mm(ceiling clearance)

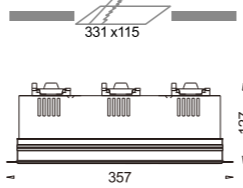

IOS INTERCHANGEABLE OPTICAL SYSTEM See P.012

White Black Silver

| ORDERING CODE | Power (W) | Beam Angle (°) | CCT (K) | Hot Lumen (Lm) | LOR (%) | UGR | On/Off | DRIVER 1-10V | DALI | Triac |
|--------------------|-----------|----------------|---------|----------------|---------|-----|--------|--------------|------|-------|
| 3FCOX800-W/B/S-830 | 3x16 | 20 | 3000 | 3x1281 | 82% | <19 | ✓ | ✓ | ✓ | ✓ |
| 3FCOX800-W/B/S-840 | | | 4000 | 3x1450 | | | | | | |
| 3FCOX800-W/B/S-850 | | | 5000 | 3x1480 | | | | | | |
| 3FCOX801-W/B/S-830 | 3x16 | 40 | 3000 | 3x1221 | 80% | <19 | ✓ | ✓ | ✓ | ✓ |
| 3FCOX801-W/B/S-840 | | | 4000 | 3x1415 | | | | | | |
| 3FCOX801-W/B/S-850 | | | 5000 | 3x1444 | | | | | | |
| 3FCOX802-W/B/S-830 | 3x16 | 55 | 3000 | 3x1191 | 78% | <19 | ✓ | ✓ | ✓ | ✓ |
| 3FCOX802-W/B/S-840 | | | 4000 | 3x1379 | | | | | | |
| 3FCOX802-W/B/S-850 | | | 5000 | 3x1407 | | | | | | |

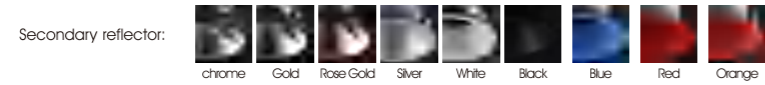
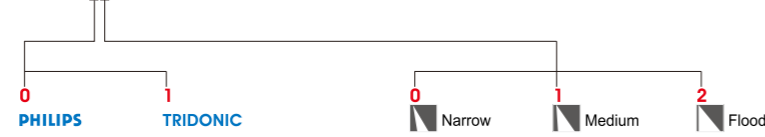

Optical accessories See P.012

PHILIPS SLM C 830 1203 L09 G1 3000K

| Beam Angle | h(m) | E(lx) | D(mm) |
|------------|------|-------|-------|
| 20° | 1.0 | 5056 | 380 |
| | 2.0 | 1264 | 760 |
| | 3.0 | 561 | 1140 |
| 40° | 1.0 | 2757 | 660 |
| | 2.0 | 689 | 1310 |
| | 3.0 | 306 | 1970 |
| 55° | 1.0 | 1790 | 940 |
| | 2.0 | 447 | 1870 |
| | 3.0 | 198 | 2810 |



BOXER SERIES MEDIUM ADJUSTABLE TRIMLESS PROJECTOR LED MULTIPLE DOWNLIGHT

160

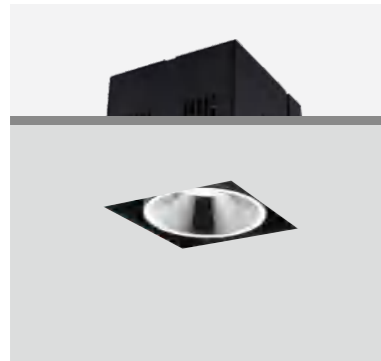

IP20 | CE | CB | |

Trim: aluminium
Body: Die-cast aluminium
Housing: Steel
Optic: High efficiency Reflector
Weight: 0.95kg
CTN: 12PCS

IO5 INTERCHANGABLE OPTICAL SYSTEM See P.012

White Black Silver

Note: min 80mm(ceiling clearance)

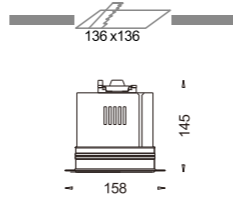

| ORDERING CODE | Power (W) | Beam Angle (°) | CCT (K) | Hot Lumen (Lm) | LOR (%) | UGR | On/Off | DRIVER 1-10V | DALI | Triac |
|----------------------------|-----------|----------------|---------|----------------|---------|-----|--------|--------------|------|-------|
| 1FCOX1000-W/B/S-830 | | | 3000 | 2411 | | | | | | |
| 1FCOX1000-W/B/S-840 | 32 | 20 | 4000 | 2698 | 84% | <19 | ✓ | ✓ | ✓ | ✓ |
| 1FCOX1000-W/B/S-850 | | | 5000 | 2752 | | | | | | |
| 1FCOX1001-W/B/S-830 | | | 3000 | 2398 | | | | | | |
| 1FCOX1001-W/B/S-840 | 32 | 40 | 4000 | 2690 | 84% | <19 | ✓ | ✓ | ✓ | ✓ |
| 1FCOX1001-W/B/S-850 | | | 5000 | 2750 | | | | | | |
| 1FCOX1002-W/B/S-830 | | | 3000 | 2392 | | | | | | |
| 1FCOX1002-W/B/S-840 | 32 | 55 | 4000 | 2680 | 84% | <19 | ✓ | ✓ | ✓ | ✓ |
| 1FCOX1002-W/B/S-850 | | | 5000 | 2730 | | | | | | |

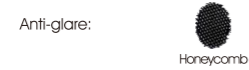
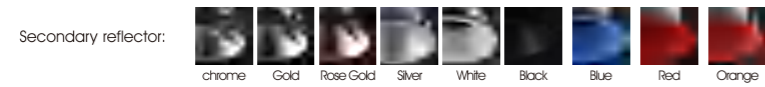
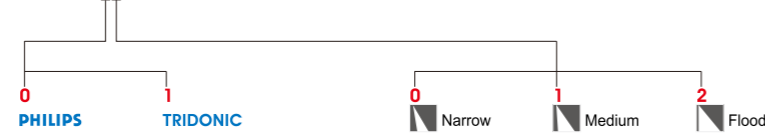

Optical accessories See P.012

PHILIPS SLM C 830 1205 L12 G1

3000K

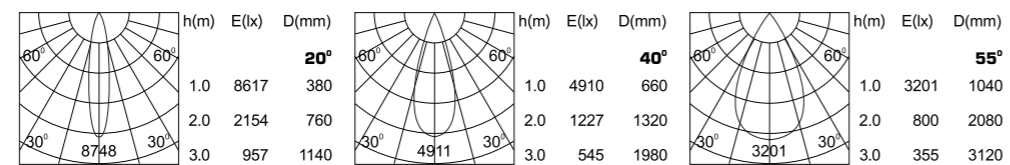

BOXER SERIES MEDIUM ADJUSTABLE TRIMLESS PROJECTOR LED MULTIPLE DOWNLIGHT

300X160



IP20 | CE | CB | |

Trim: aluminium
Body: Die-cast aluminium
Housing: Steel
Optic: High efficiency Reflector
Weight: 1.7kg
CTN: 6PCS

IO5 INTERCHANGABLE OPTICAL SYSTEM See P.012

White Black Silver

Note: min 80mm(ceiling clearance)

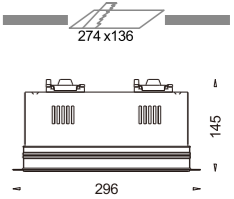

| ORDERING CODE | Power (W) | Beam Angle (°) | CCT (K) | Hot Lumen (Lm) | LOR (%) | UGR | On/Off | DRIVER 1-10V | DALI | Triac |
|----------------------------|-----------|----------------|---------|----------------|---------|-----|--------|--------------|------|-------|
| 2FCOX1000-W/B/S-830 | | | 3000 | 2x2411 | | | | | | |
| 2FCOX1000-W/B/S-840 | 2x32 | 20 | 4000 | 2x2698 | 84% | <19 | ✓ | ✓ | ✓ | ✓ |
| 2FCOX1000-W/B/S-850 | | | 5000 | 2x2752 | | | | | | |
| 2FCOX1001-W/B/S-830 | | | 3000 | 2x2398 | | | | | | |
| 2FCOX1001-W/B/S-840 | 2x32 | 40 | 4000 | 2x2690 | 84% | <19 | ✓ | ✓ | ✓ | ✓ |
| 2FCOX1001-W/B/S-850 | | | 5000 | 2x2750 | | | | | | |
| 2FCOX1002-W/B/S-830 | | | 3000 | 2x2392 | | | | | | |
| 2FCOX1002-W/B/S-840 | 2x32 | 55 | 4000 | 2x2680 | 84% | <19 | ✓ | ✓ | ✓ | ✓ |
| 2FCOX1002-W/B/S-850 | | | 5000 | 2x2730 | | | | | | |

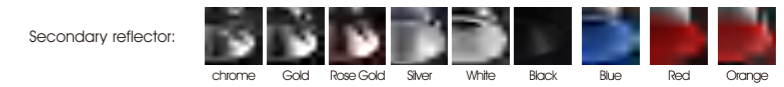
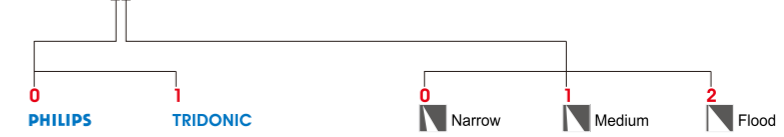

Optical accessories See P.012

PHILIPS SLM C 830 1205 L12 G1

3000K

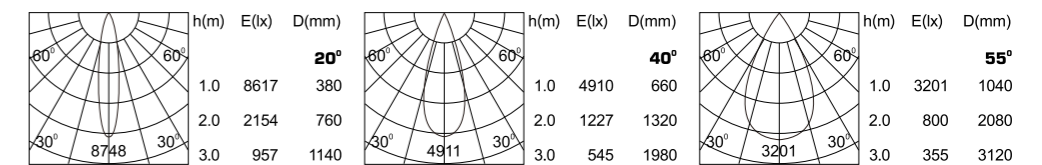



BOXER SERIES MEDIUM ADJUSTABLE TRIMLESS PROJECTOR
LED MULTIPLE DOWNLIGHT

435X160



IP20 | CE | CB |

Trim: aluminium
Body: Die-cast aluminium
Housing: Steel
Optic: High efficiency Reflector
Weight: 2.5kg
CTN: 4PCS

Note: min 80mm(ceiling clearance)

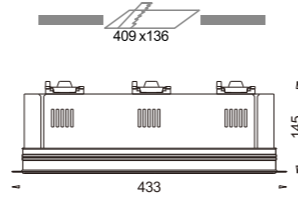

IOS INTERCHANGEABLE OPTICAL SYSTEM See P.012

White Black Silver

| ORDERING CODE | Power (W) | Beam Angle (°) | CCT (K) | Hot Lumen (Lm) | LOR (%) | UGR | On/Off | DRIVER 1-10V | DALI | Triac |
|---------------------|-----------|----------------|---------|----------------|---------|-----|--------|--------------|------|-------|
| 3FCOX1000-W/B/S-830 | 3x32 | 20 | 3000 | 3x2411 | 84% | <19 | ✓ | ✓ | ✓ | ✓ |
| 3FCOX1000-W/B/S-840 | | | 4000 | 3x2698 | | | | | | |
| 3FCOX1000-W/B/S-850 | | | 5000 | 3x2752 | | | | | | |
| 3FCOX1001-W/B/S-830 | 3x32 | 40 | 3000 | 3x2398 | 84% | <19 | ✓ | ✓ | ✓ | ✓ |
| 3FCOX1001-W/B/S-840 | | | 4000 | 3x2690 | | | | | | |
| 3FCOX1001-W/B/S-850 | | | 5000 | 3x2750 | | | | | | |
| 3FCOX1002-W/B/S-830 | 3x32 | 55 | 3000 | 3x2392 | 84% | <19 | ✓ | ✓ | ✓ | ✓ |
| 3FCOX1002-W/B/S-840 | | | 4000 | 3x2680 | | | | | | |
| 3FCOX1002-W/B/S-850 | | | 5000 | 3x2730 | | | | | | |

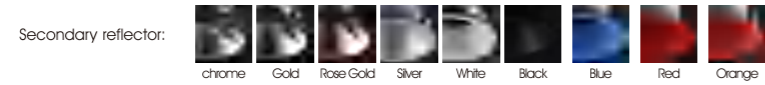
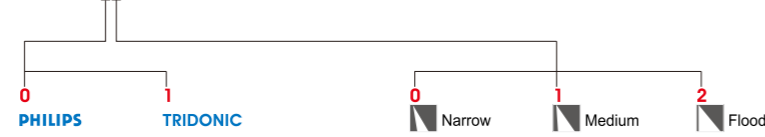

Optical accessories See P.012

PHILIPS SLM C 830 1205 L12 G1

3000K

| Beam Angle | h(m) | E(lx) | D(mm) |
|------------|------|-------|-------|
| 20° | 1.0 | 8617 | 380 |
| | 2.0 | 2154 | 760 |
| | 3.0 | 957 | 1140 |
| 40° | 1.0 | 4910 | 660 |
| | 2.0 | 1227 | 1320 |
| | 3.0 | 545 | 1980 |
| 55° | 1.0 | 3201 | 1040 |
| | 2.0 | 800 | 2080 |
| | 3.0 | 355 | 3120 |

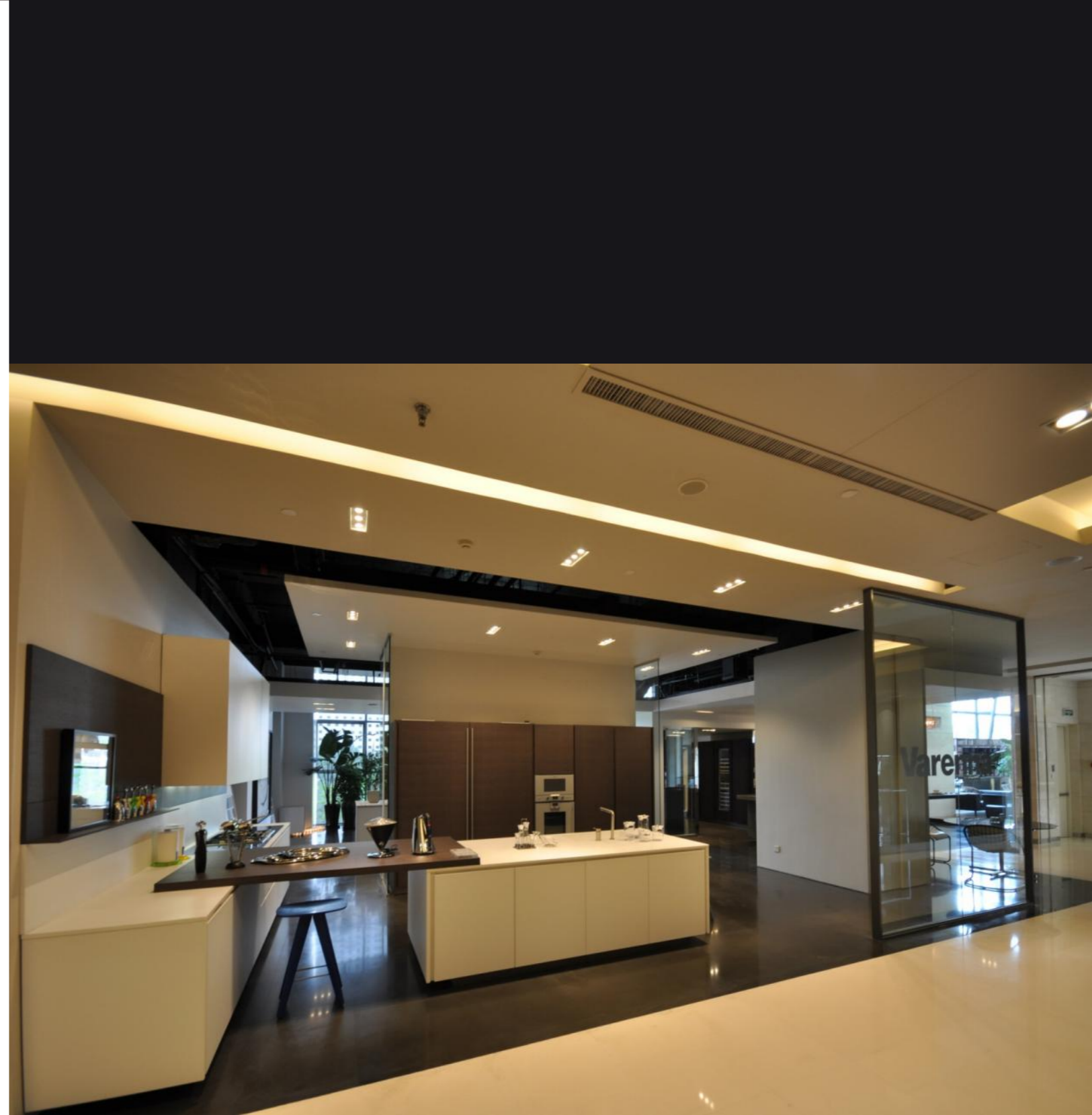

BOXER SERIES LARGE ADJUSTABLE TRIMLESS PROJECTOR
LED MULTIPLE DOWNLIGHT

190

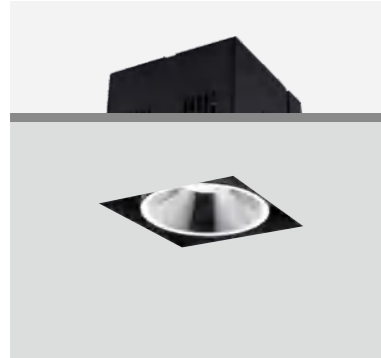

IP20 | CE | CB |

Trim: aluminium
Body: Die-cast aluminium
Housing: Steel
Optic: High efficiency Reflector
Weight: 1.4kg
CTN: 8PCS

IO5 INTERCHANGIBLE OPTICAL SYSTEM See P.012

White Black Silver

Note: min 80mm(ceiling clearance)

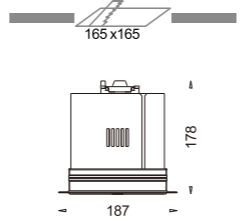

| ORDERING CODE | Power (W) | Beam Angle (°) | CCT (K) | Hot Lumen (Lm) | LOR (%) | UGR | On/Off | DRIVER 1-10V | DALI | Triac |
|---------------------|-----------|----------------|---------|----------------|---------|-----|--------|--------------|------|-------|
| 1FCOX1200-W/B/S-830 | | | 3000 | 3147 | | | | | | |
| 1FCOX1200-W/B/S-840 | 38 | 20 | 4000 | 3586 | 84% | <19 | ✓ | ✓ | ✓ | ✓ |
| 1FCOX1200-W/B/S-850 | | | 5000 | 3534 | | | | | | |
| 1FCOX1201-W/B/S-830 | | | 3000 | 3089 | | | | | | |
| 1FCOX1201-W/B/S-840 | 38 | 40 | 4000 | 3544 | 83% | <19 | ✓ | ✓ | ✓ | ✓ |
| 1FCOX1201-W/B/S-850 | | | 5000 | 3492 | | | | | | |
| 1FCOX1202-W/B/S-830 | | | 3000 | 3042 | | | | | | |
| 1FCOX1202-W/B/S-840 | 38 | 55 | 4000 | 3501 | 82% | <19 | ✓ | ✓ | ✓ | ✓ |
| 1FCOX1202-W/B/S-850 | | | 5000 | 3450 | | | | | | |

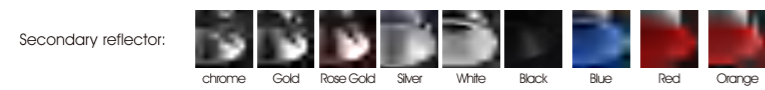
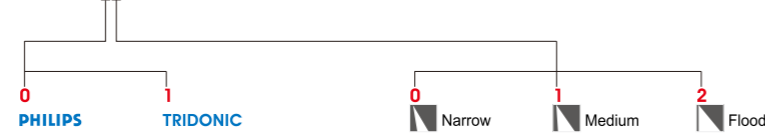

Optical accessories See P.012

PHILIPS SLM C 830 1208 L14 G1

3000K

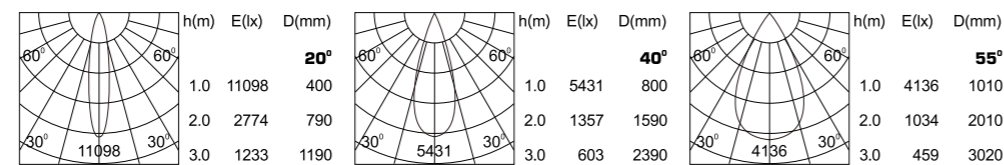

BOXER SERIES LARGE ADJUSTABLE TRIMLESS PROJECTOR
LED MULTIPLE DOWNLIGHT

360X190



IP20 | CE | CB |

Trim: aluminium
Body: Die-cast aluminium
Housing: Steel
Optic: High efficiency Reflector
Weight: 2.56kg
CTN: 6PCS

IO5 INTERCHANGIBLE OPTICAL SYSTEM See P.012

White Black Silver

Note: min 80mm(ceiling clearance)

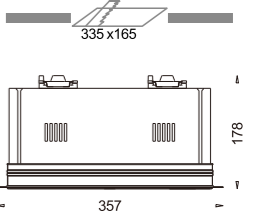

| ORDERING CODE | Power (W) | Beam Angle (°) | CCT (K) | Hot Lumen (Lm) | LOR (%) | UGR | On/Off | DRIVER 1-10V | DALI | Triac |
|---------------------|-----------|----------------|---------|----------------|---------|-----|--------|--------------|------|-------|
| 2FCOX1200-W/B/S-830 | | | 3000 | 2x3147 | | | | | | |
| 2FCOX1200-W/B/S-840 | 2x38 | 20 | 4000 | 2x3586 | 84% | <19 | ✓ | ✓ | ✓ | ✓ |
| 2FCOX1200-W/B/S-850 | | | 5000 | 2x3534 | | | | | | |
| 2FCOX1201-W/B/S-830 | | | 3000 | 2x3089 | | | | | | |
| 2FCOX1201-W/B/S-840 | 2x38 | 40 | 4000 | 2x3544 | 83% | <19 | ✓ | ✓ | ✓ | ✓ |
| 2FCOX1201-W/B/S-850 | | | 5000 | 2x3492 | | | | | | |
| 2FCOX1202-W/B/S-830 | | | 3000 | 2x3042 | | | | | | |
| 2FCOX1202-W/B/S-840 | 2x38 | 55 | 4000 | 2x3501 | 82% | <19 | ✓ | ✓ | ✓ | ✓ |
| 2FCOX1202-W/B/S-850 | | | 5000 | 2x3450 | | | | | | |

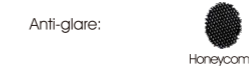
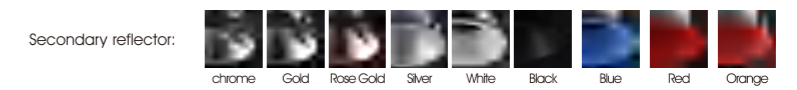
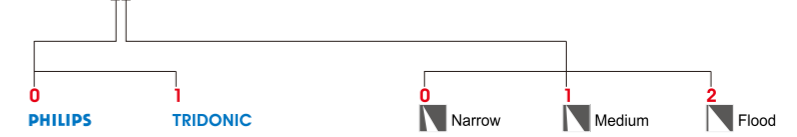

Optical accessories See P.012

PHILIPS SLM C 830 1208 L14 G1

3000K

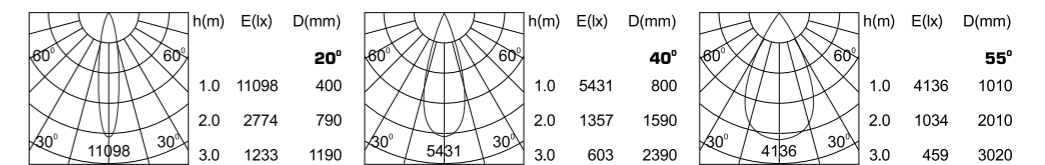



BOXER SERIES LARGE ADJUSTABLE TRIMLESS PROJECTOR
LED MULTIPLE DOWNLIGHT

530X190



IP20 | CE | CB |

Trim: aluminium
Body: Die-cast aluminium
Housing: Steel
Optic: High efficiency Reflector
Weight: 3.7kg
CTN: 4PCS

IOS INTERCHANGEABLE OPTICAL SYSTEM See P.012

White Black Silver

Note: min 80mm(ceiling clearance)

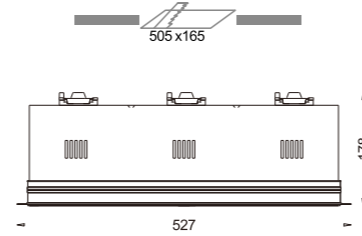

| ORDERING CODE | Power (W) | Beam Angle (°) | CCT (K) | Hot Lumen (Lm) | LOR (%) | UGR | On/Off | DRIVER 1-10V | DALI | Triac |
|---------------------|-----------|----------------|---------|----------------|---------|-----|--------|--------------|------|-------|
| 3FCOX1200-W/B/S-830 | 3x38 | 20 | 3000 | 3x3147 | 84% | <19 | ✓ | ✓ | ✓ | ✓ |
| 3FCOX1200-W/B/S-840 | | | 4000 | 3x3586 | | | | | | |
| 3FCOX1200-W/B/S-850 | | | 5000 | 3x3534 | | | | | | |
| 3FCOX1201-W/B/S-830 | 3x38 | 40 | 3000 | 3x3089 | 83% | <19 | ✓ | ✓ | ✓ | ✓ |
| 3FCOX1201-W/B/S-840 | | | 4000 | 3x3544 | | | | | | |
| 3FCOX1201-W/B/S-850 | | | 5000 | 3x3492 | | | | | | |
| 3FCOX1202-W/B/S-830 | 3x38 | 55 | 3000 | 3x3042 | 82% | <19 | ✓ | ✓ | ✓ | ✓ |
| 3FCOX1202-W/B/S-840 | | | 4000 | 3x3501 | | | | | | |
| 3FCOX1202-W/B/S-850 | | | 5000 | 3x3450 | | | | | | |

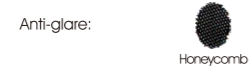
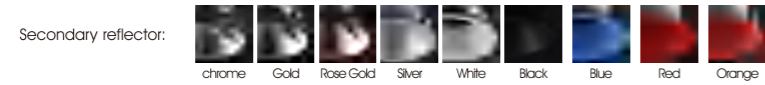
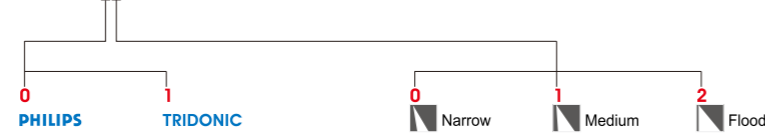

Optical accessories See P.012

PHILIPS SLM C 830 1208 L14 G1

3000K

| h(m) | E(lx) | D(mm) | h(m) | E(lx) | D(mm) | h(m) | E(lx) | D(mm) |
|------|-------|-------|------|-------|-------|------|-------|-------|
| 20° | | | 40° | | | 55° | | |
| 1.0 | 11098 | 400 | 1.0 | 5431 | 800 | 1.0 | 4136 | 1010 |
| 2.0 | 2774 | 790 | 2.0 | 1357 | 1590 | 2.0 | 1034 | 2010 |
| 3.0 | 1233 | 1190 | 3.0 | 603 | 2390 | 3.0 | 459 | 3020 |



BOXER SERIES LARGE ADJUSTABLE TRIMLESS PROJECTOR
LED MULTIPLE DOWNLIGHT

No frame ceiling installation

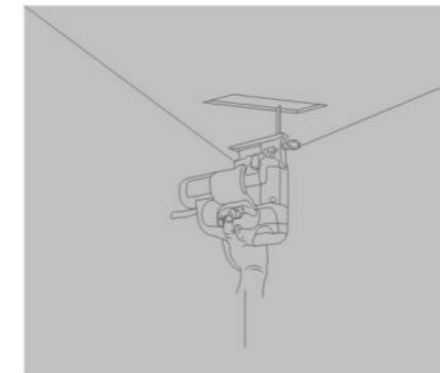

According to the data, open the appropriate mounting holes in the blooming board;

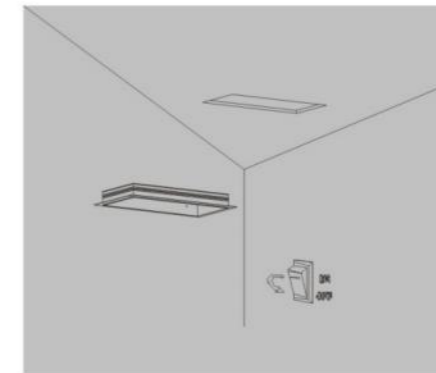

Turn off the power switch; Measuring the thickness of the ceiling, adjusting the no frame to the appropriate size, and locking the

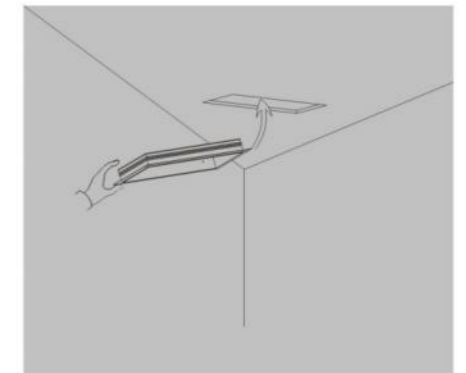

The lamp frame up, into the ceiling;

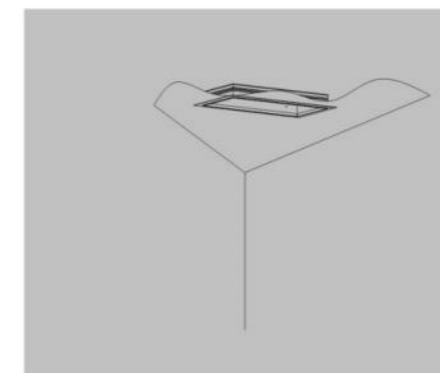

The lamp frame level down, and the center;

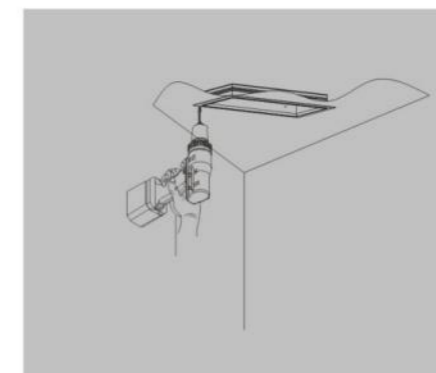

Use the tip of the tail screw in the packing box, the position of the locking plate in the frame;

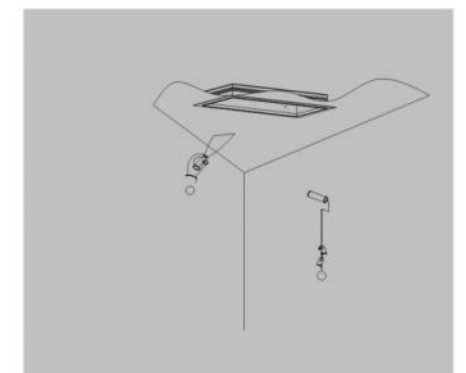

The outer periphery and screw position wall dust disappearing;

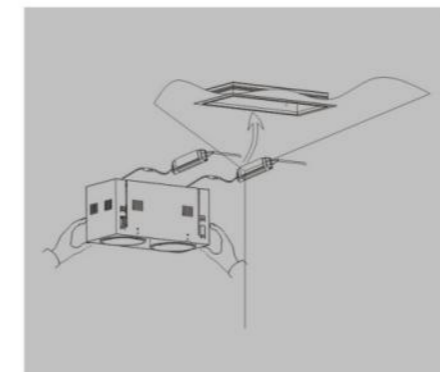

Connect the lamp driver to the end of the line;

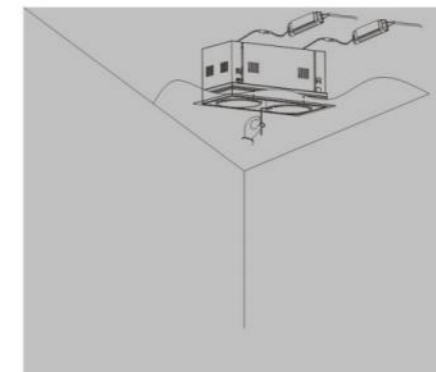

The lamp and drive into the frame, hear "click" sound, see the lamp is stable;

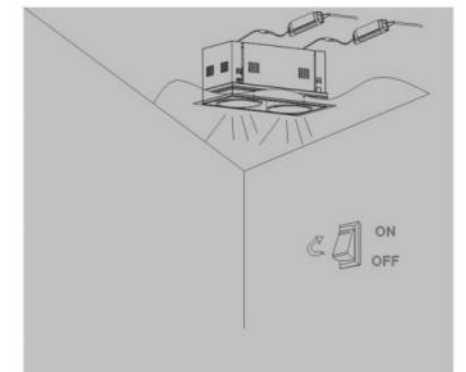

Turn on the power supply, and adjust the angle of the normal use of the lamps;