

Declaration:  
The technical information and appearance of products appearing in this catalogue is indicative only and subject to revision.

**VIMETA**<sup>®</sup>  
TECHNICAL LIGHTING

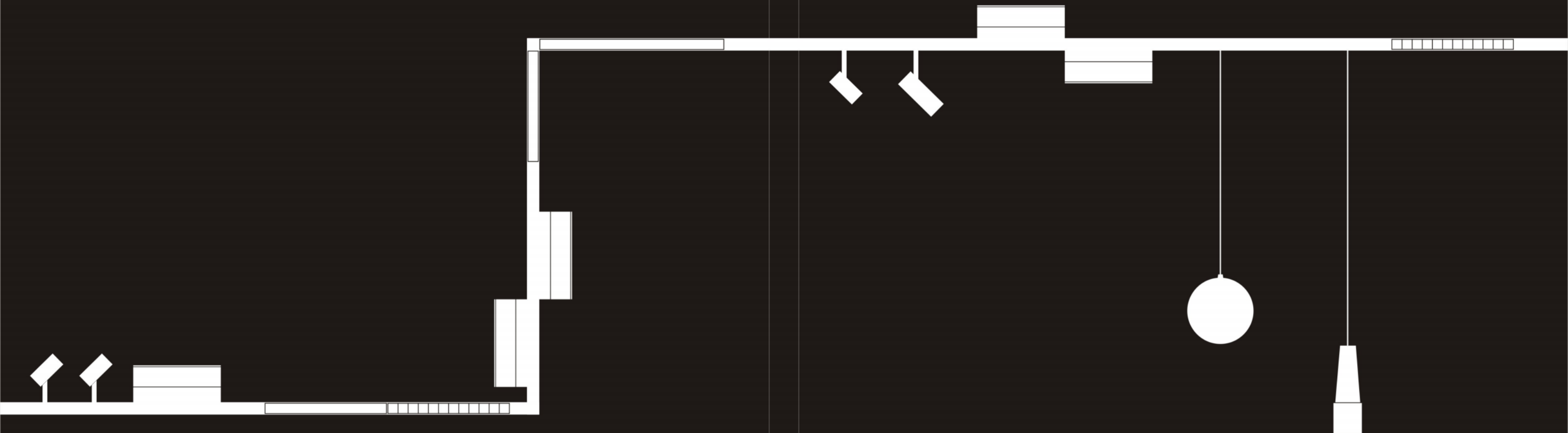

We Put Project in Lights



We Put Project In Lights

# CONTENTS

## DC48V Magneto Track system

8



Surface mount  
Pendant



Recessed(trim)



Recessed(trimless)

## DC48V magneto system

14

I TYPE Linear Lighting System



△ TYPE Linear Lighting System



□ TYPE Linear Lighting System



I TYPE Fire Floor System



L TYPE Fire Floor System



## DC48V magneto system

32

MAGNETO CUBE SERIES



MAGNETO WALL WASHER FIXED SERIES



MAGNETO LINEAR SERIES ADJUSTABLE PROJECTOR



MAGNETO CUBE SERIES ADJUSTABLE PROJECTOR



MAGNETO EYE SERIES ADJUSTABLE PROJECTOR



MAGNETO LINEAR SERIES



MAGNETO CUBE SERIES ADJUSTABLE PROJECTOR



MAGNETO COBRA WALL WASHER SERIES



MAGNETO MICRO SERIES ADJUSTABLE PROJECTOR



MAGNETO EYE SERIES PENDANT



MAGNETO EYE SERIES ADJUSTABLE PROJECTOR  
DC48V MAGNETO SYSTEM



IP20 | CE | CB | | | | | | | | | |

Body: aluminium  
Housing: aluminium  
Optic: High efficiency Reflector



**IOS** See P012

Black White

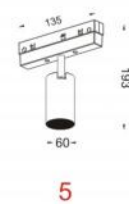

ORDERING CODE	Power (W)	Beam Angle (°)	CCT (K)	Hot Lumen (Lm)	LOR (%)	UGR	CRI	DRIVER	On/Off	Bluetooth	Dali
S180X-B/W-930	12	20/40/55	3000	1440	75%	<19	>90	✓			
S180X-B/W-940			4000	1470							
S181X-B/W-930	12	20/40/55	3000	1440	75%	<19	>90		✓		
S181X-B/W-940			4000	1470							
S182X-B/W-930	12	20/40/55	3000	1440	75%	<19	>90			✓	
S182X-B/W-940			4000	1470							

Weight: 0.37kg  
CTN: 20PCS



- 7 Secondary reflector: chrome Gold Rose Gold Silver White Black Blue Red Orange
  - 7 Color Lens:
  - 7 Diffuser Lens: Elliptical Prismatic Faceted
  - 7 Anti-glare: Honeycomb IR90
- Optical accessories See P012

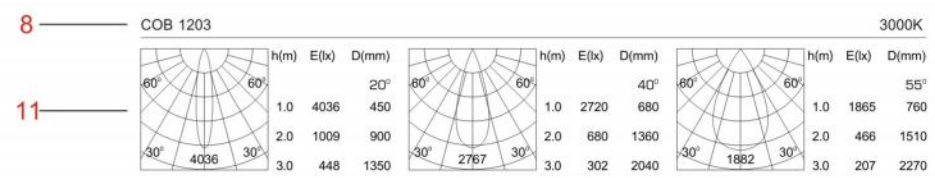

0. Fixture name.  
Indicates the name and size of an series.

1. Frame dimensions  
Indicates the fixture's trim dimensions.



2. Compatible lamps  
For safety reasons, only the indicated lamps should be used.  
Please be sure to also check lamp specifications and restrictions.

3. Material, finish, weight, special notes, etc.  
Materials and finishes are subject to change without prior notification for quality improvement purposes.

4. Ceiling cut  
Indicates the ceiling hole cut for installation.

5. Fixtures dimensions.  
Dimensions are noted in simplified form the outline drawings or multiple view diagrams. Dimensions included in parentheses indicate measurements for which there is a small amount of variation between products. "Specification Diagrams" with more detailed information's are available by request.

6. Icons

- High efficiency alumi-mirror icon  
Indicates the use of a high-efficiency reflector.
- IR-cut dichroic mirror icon  
Indicates the use of a mirror that cuts at least 80%of infrared radiation (heat).
- Turning angle icon  
Indicates the fixture's maximum angle of vertical tilt.
- Swing angle icon  
Indicates the fixture's maximum angle of horizontal swing.
- Fast connections male/female connector plug.
- Emergency unit's accessories.
- Anti-Glare device integrated.
- Interchangeable reflector for all application of use.
- LED ITEM No.
- Model number when ordering.
- Fixture colour or accessories parts.  
Indicates fixture colours eg, -W white  
-B white  
-S sliver
- Light distributions diagrams.  
Indicates the photometric of the light intensity.
- 40°x40° Adjustable
- Glare cut icon  
Indicates the glare cut angle
- Ingress protection level icon  
Left digit indicates waterproofing Right digit indicates dust resistance  
Larger numbers indicate superior protection
- "F" icon  
Indicates the fixture with built-in power packs or transformers.  
Suitable for mounting directly on normally inflammable surfaces.
- Luminaire not suitable for direct mounting on normally inflammable surfaces.
- Class I fittings.
- Class II fittings.
- Class III fittings.
- Turning angle icon  
Indicates the track fixture's maximum angle of vertical tilt.

Track (2m/3m)

DC48V 450W(Max)

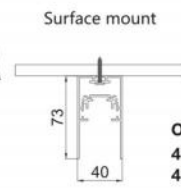

ORDERING CODE:  
48VS2000  
48VS3000

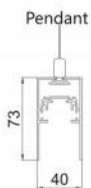

ORDERING CODE:  
48VSP2000  
48VSP3000

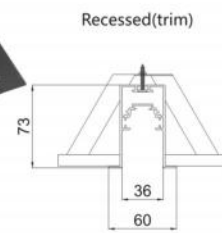

ORDERING CODE:  
48VRT2000  
48VRT3000

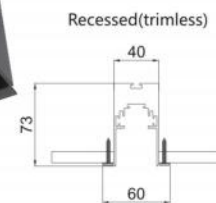

ORDERING CODE:  
48VT2000  
48VT3000

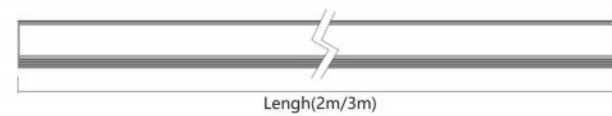

Length(2m/3m)





48V Track Mechanical Connector



**LLI1000**  
DC48V Magneto System  
Track Straight joints connector:  
Recessed housing  
Recessed trimless housing  
Surface housing  
Pendant housing



**LLR1000**  
DC48V Magneto System  
90° Track Horizontal left/right connector:  
Recessed housing  
Recessed trimless housing  
Surface housing  
Pendant housing



**LEX1000**  
DC48V Magneto System  
90° Track Vertical down(inwards) connector:  
Recessed housing  
Recessed trimless housing  
Surface housing  
Pendant housing

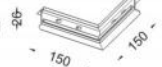

**LIN1000**  
DC48V Magneto System  
90° Track Vertical up(outwards) connector :  
Recessed housing  
Recessed trimless housing  
Surface housing  
Pendant housing



48V Track Electrical Connector

DC48V 450W(Max)



**VMC1200**  
DC48V Magneto System  
Input Electrical connector:  
Recessed housing  
Recessed trimless housing  
Surface housing  
Pendant housing



**VMC1000**  
DC48V Magneto System  
Universal electrical connector:  
Recessed housing  
Recessed trimless housing  
Surface housing  
Pendant housing



**VMC1100**  
DC48V Magneto System  
Straight joint connector:  
Recessed housing  
Recessed trimless housing  
Surface housing  
Pendant housing



**PV4811**  
100W  
220-240V AC Input  
48V DC Output

48V Track Accessory

DC48V 450W(Max)



**PS-102**  
Recessed Installation Brackets  
Fixed Accessories



**TJ-094**  
Side Cover End-Cap  
For Track(Pendant/surface/trimless mount)



**TJ-128**  
Side Cover End-Cap  
For Track(Recessed)



**TXP160**  
1.6M  
Suspension wire



**TXP300**  
3M  
Suspension wire



**TXS100**  
Ceiling installation kit



**CANS890**  
Suspension gearbox



**PV4810**  
100W  
220-240V AC Input  
48V DC Output  
Suspension gearbox



**PV4815**  
150W  
220-240V AC Input  
48V DC Output  
Suspension gearbox



**PV4820**  
200W  
220-240V AC Input  
48V DC Output  
Suspension gearbox

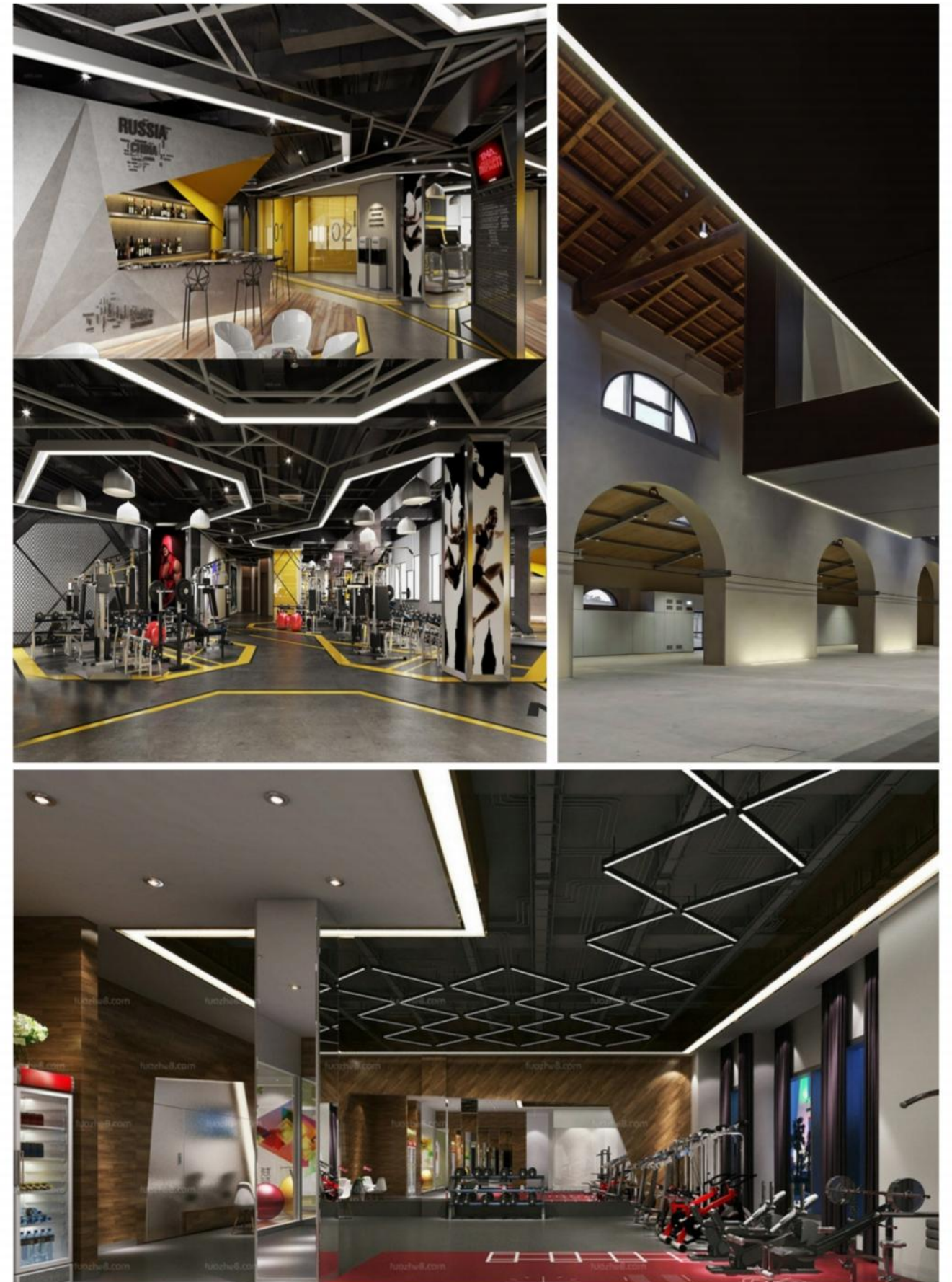



### Z TYPE Linear Lighting System

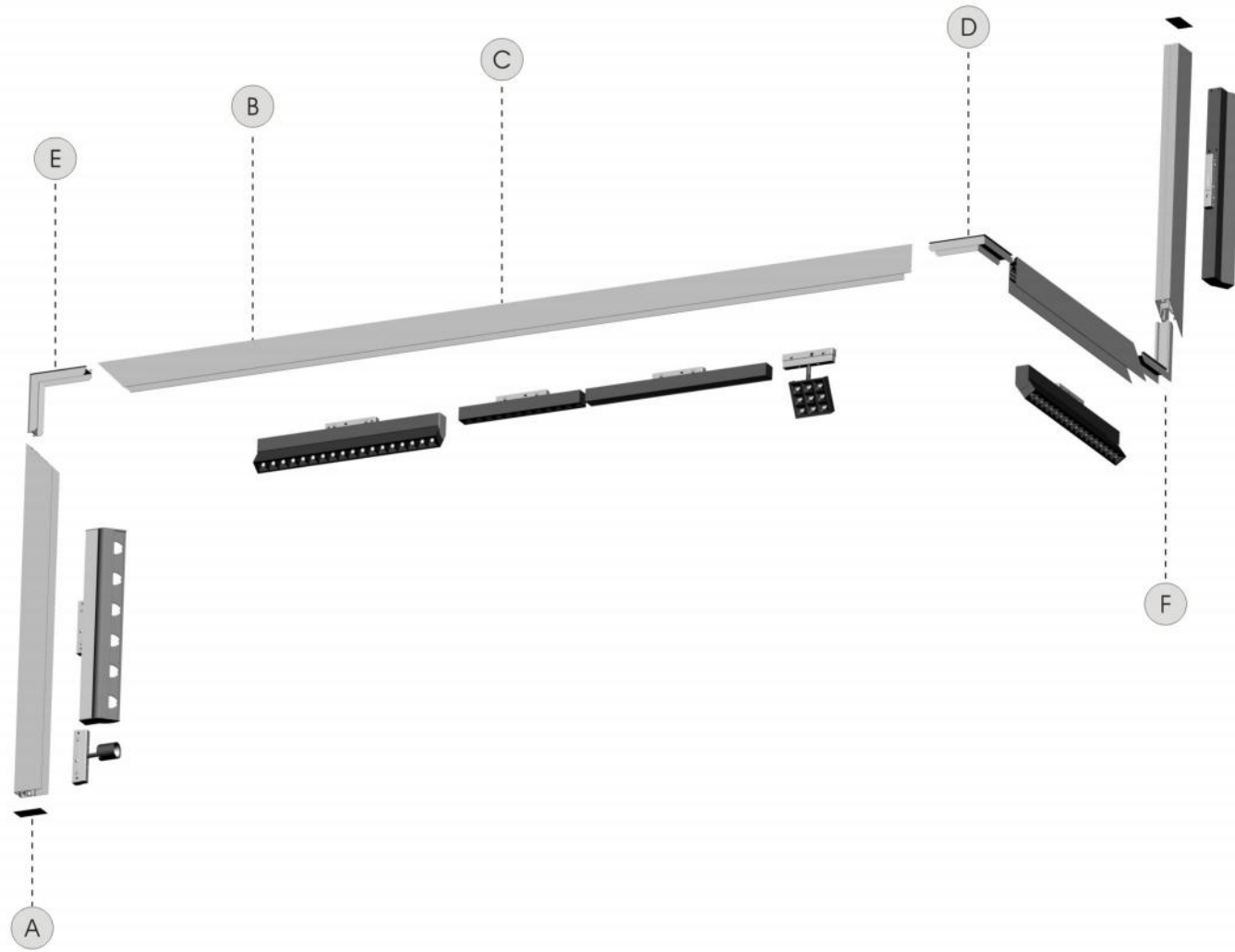

#### Track Mechanical Connector



#### Electrical Connector

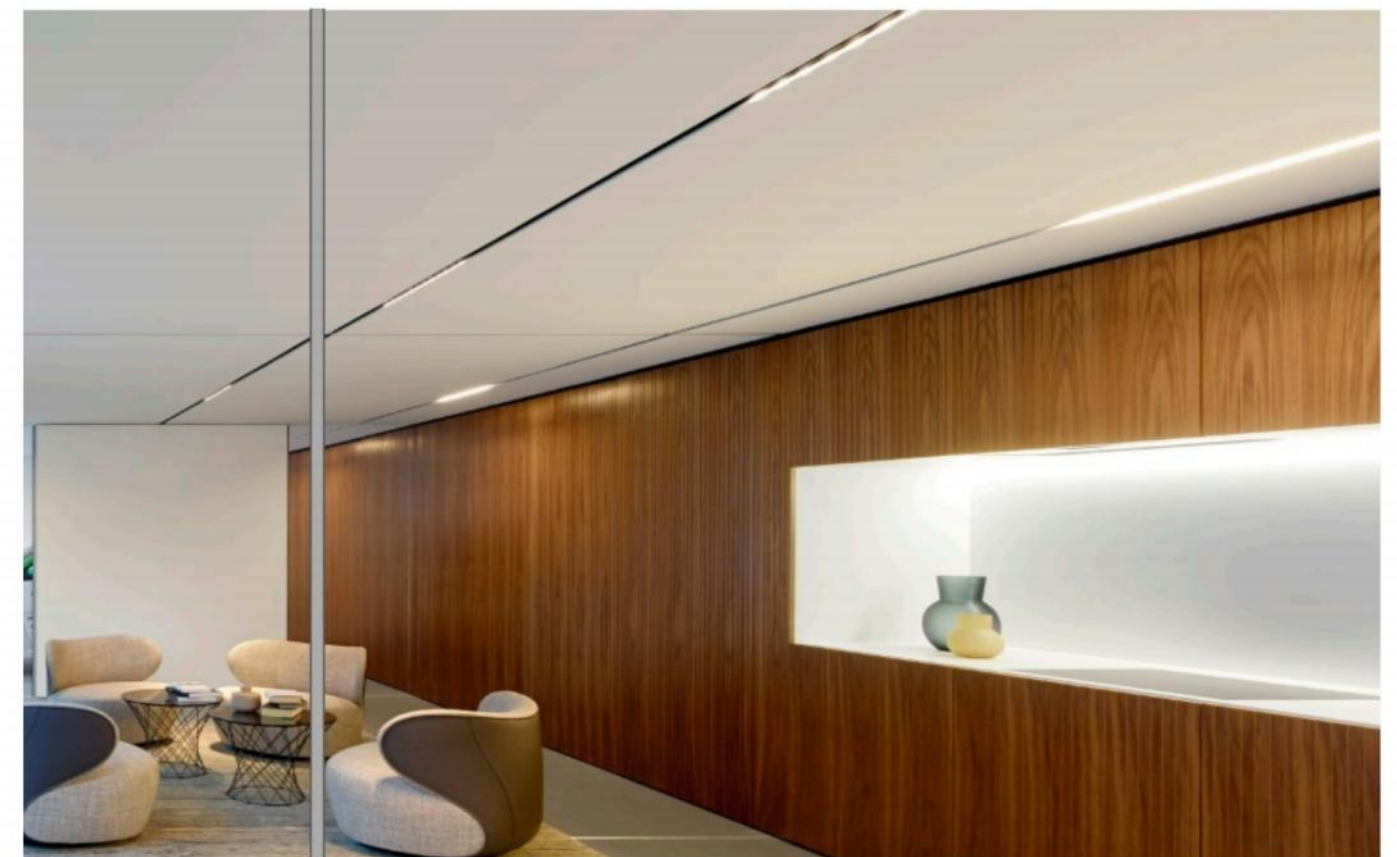

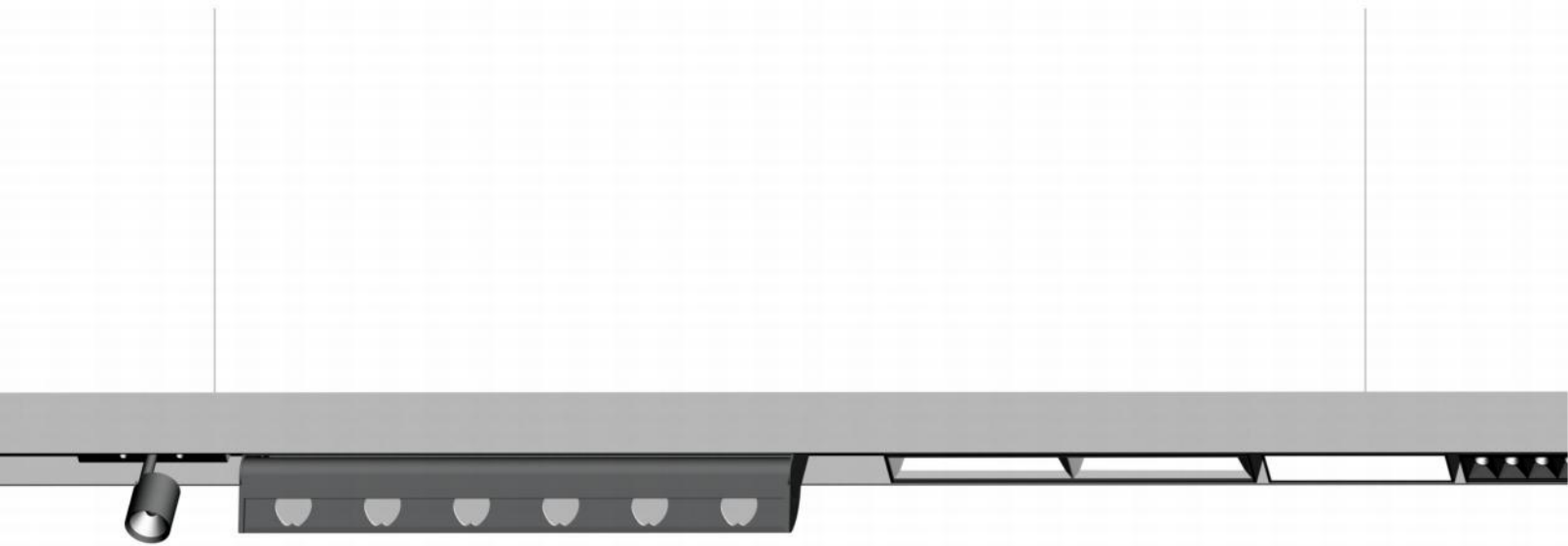

**I TYPE** Linear Lighting System  
Combo pack

Ordering Code:

**48VS1200**



**48VS1800**

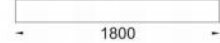

**48VS2400**



Suspended track  
Surface track

Ordering Code:

**48VRT1200**

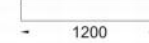

**48VRT1800**

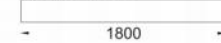

**48VRT2400**

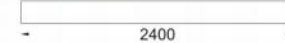

Trim Recessed track

Ordering Code:

**48VT1200**



**48VT1800**

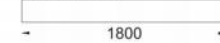

**48VT2400**



Trimless Recessed track

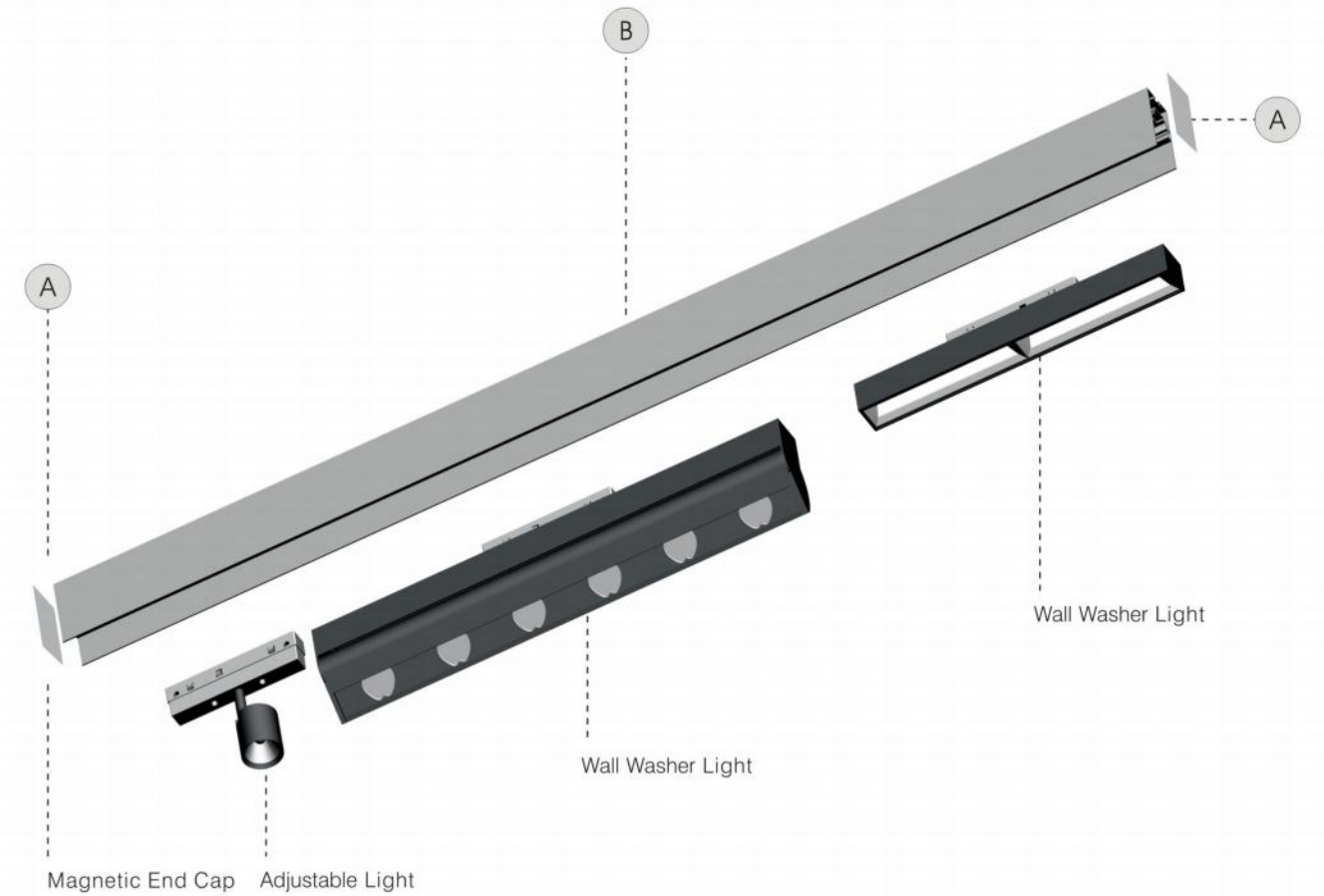
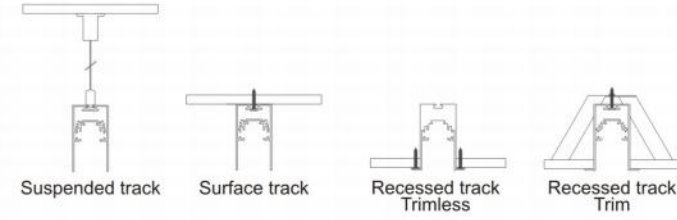

**Track Mechanical Connector**



**Electrical Connector**





□ TYPE Linear Lighting System  
Combo pack

Ordering Code:  
MAGT1200x2400

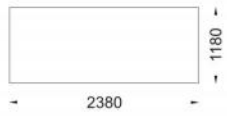

Ordering Code:  
MAGT1200x1200

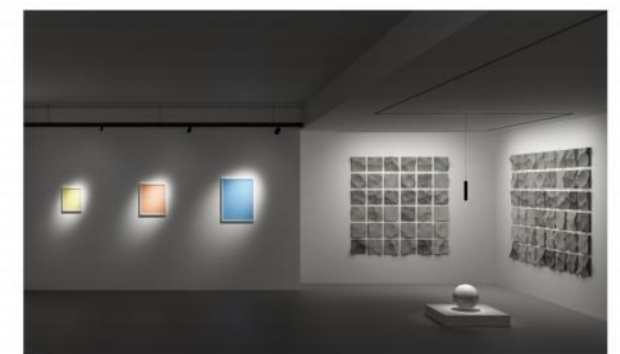
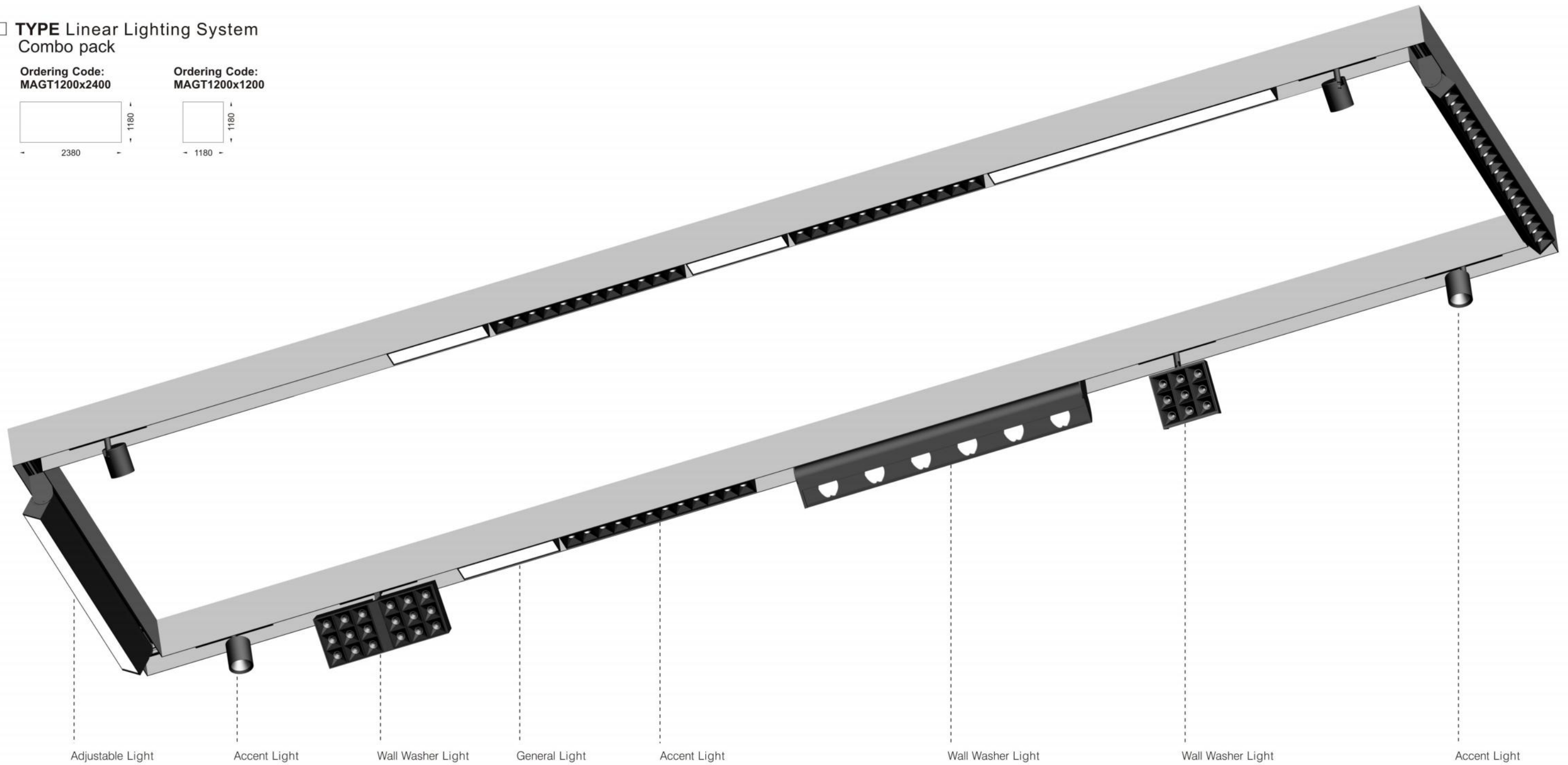
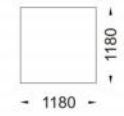

□ TYPE Linear Lighting System  
Combo pack

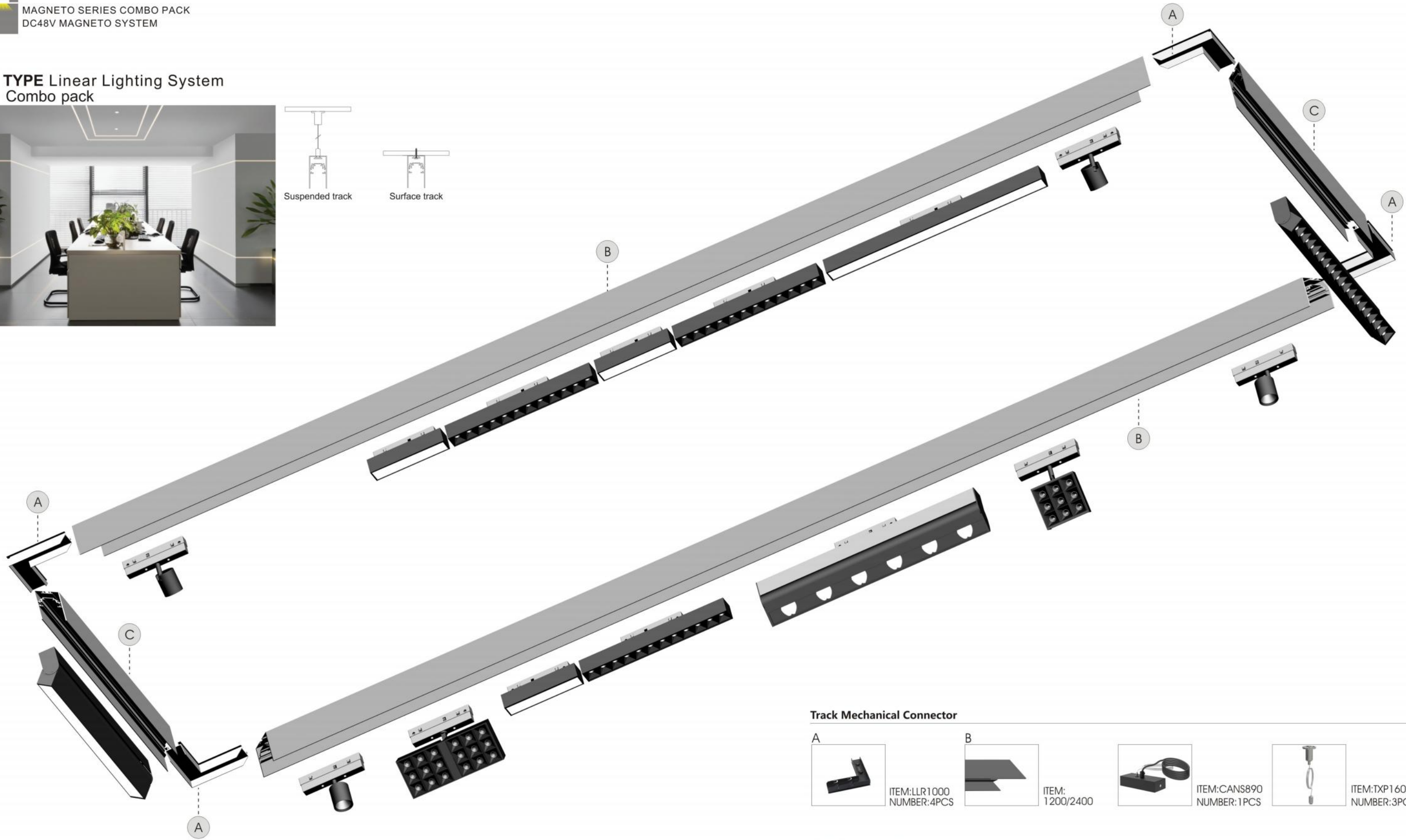
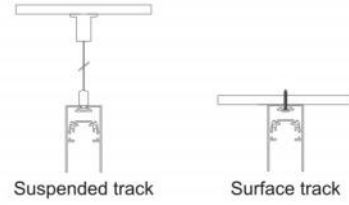

Track Mechanical Connector

	<p>ITEM:LLR1000 NUMBER:4PCS</p>		<p>ITEM: 1200/2400</p>		<p>ITEM:CANS890 NUMBER:1PCS</p>		<p>ITEM:TXP160 NUMBER:3PCS</p>
---	-------------------------------------	---	----------------------------	---	-------------------------------------	---	------------------------------------

Electrical Connector

	<p>ITEM:VMC1200 NUMBER:1PCS</p>		<p>ITEM:VMC1000 NUMBER:3PCS</p>
---	-------------------------------------	---	-------------------------------------







△ **TYPE** Linear Lighting System  
Combo pack

Ordering Code:  
MAGT31800

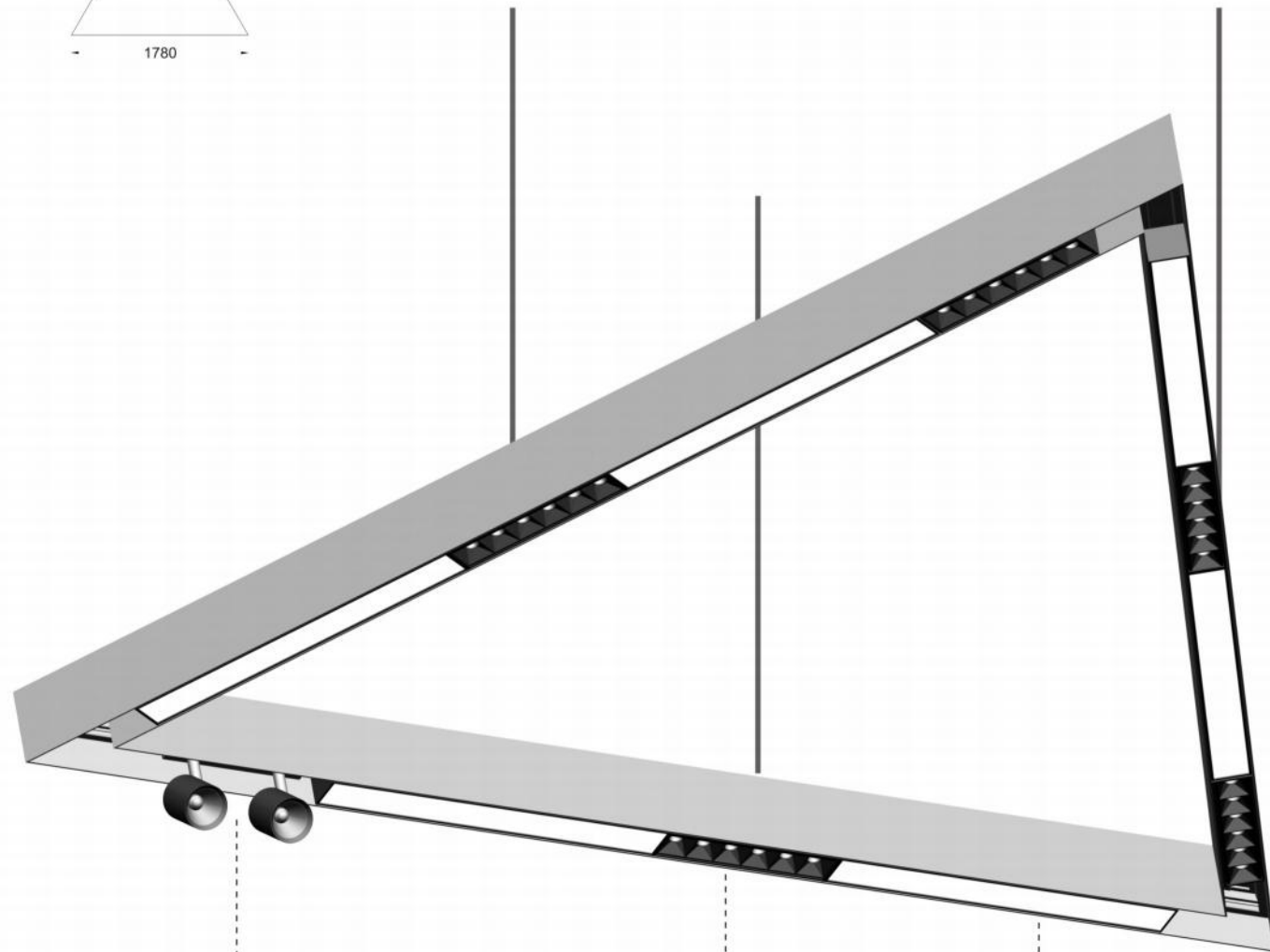
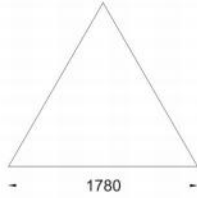

Adjustable Light

Accent Light

General Light

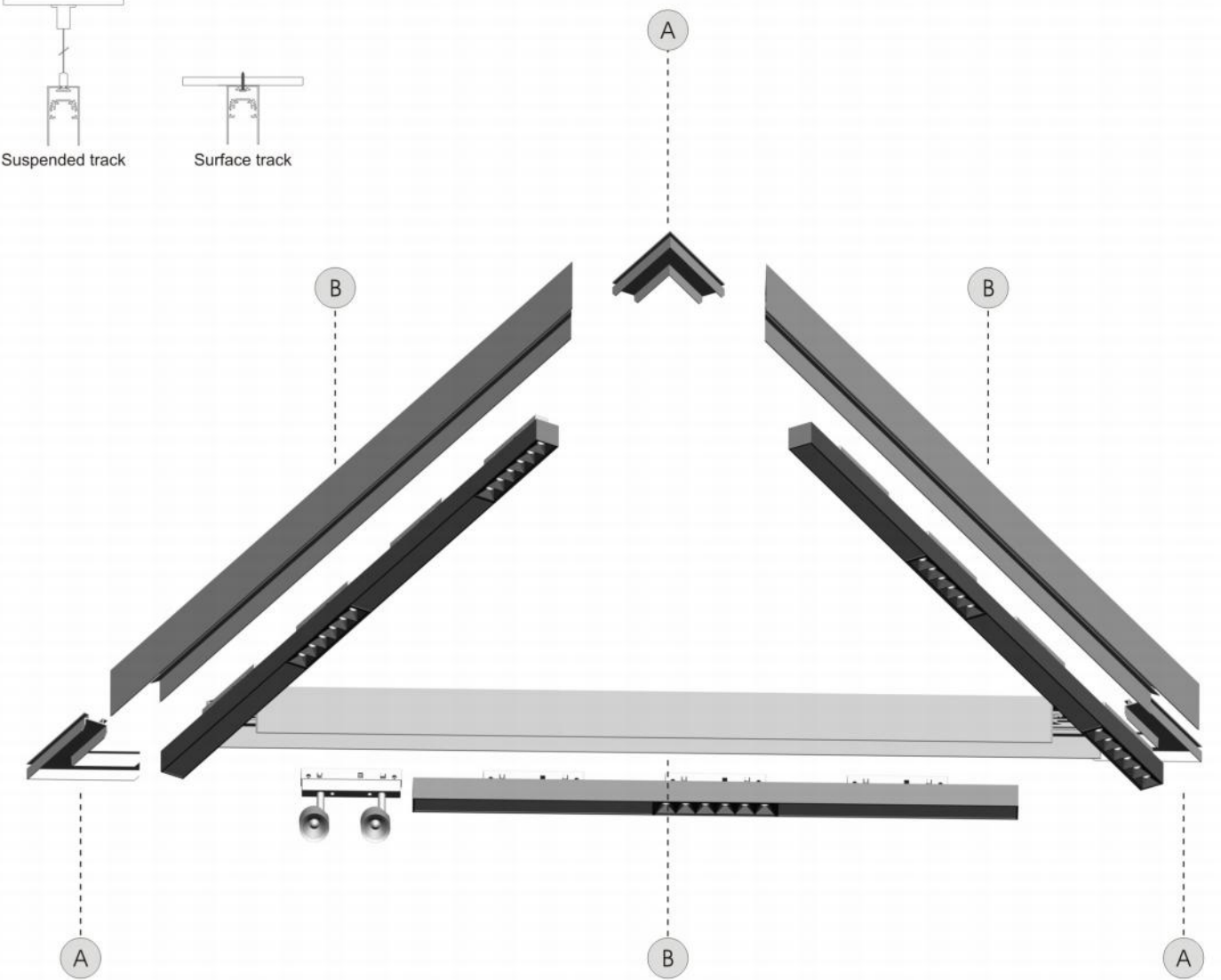
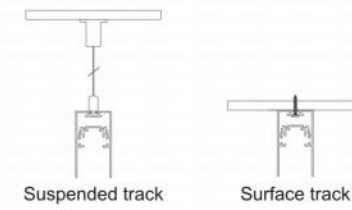

**Track Mechanical Connector**



**Electrical Connector**



**I TYPE Free Stand Floor System**  
Combo pack

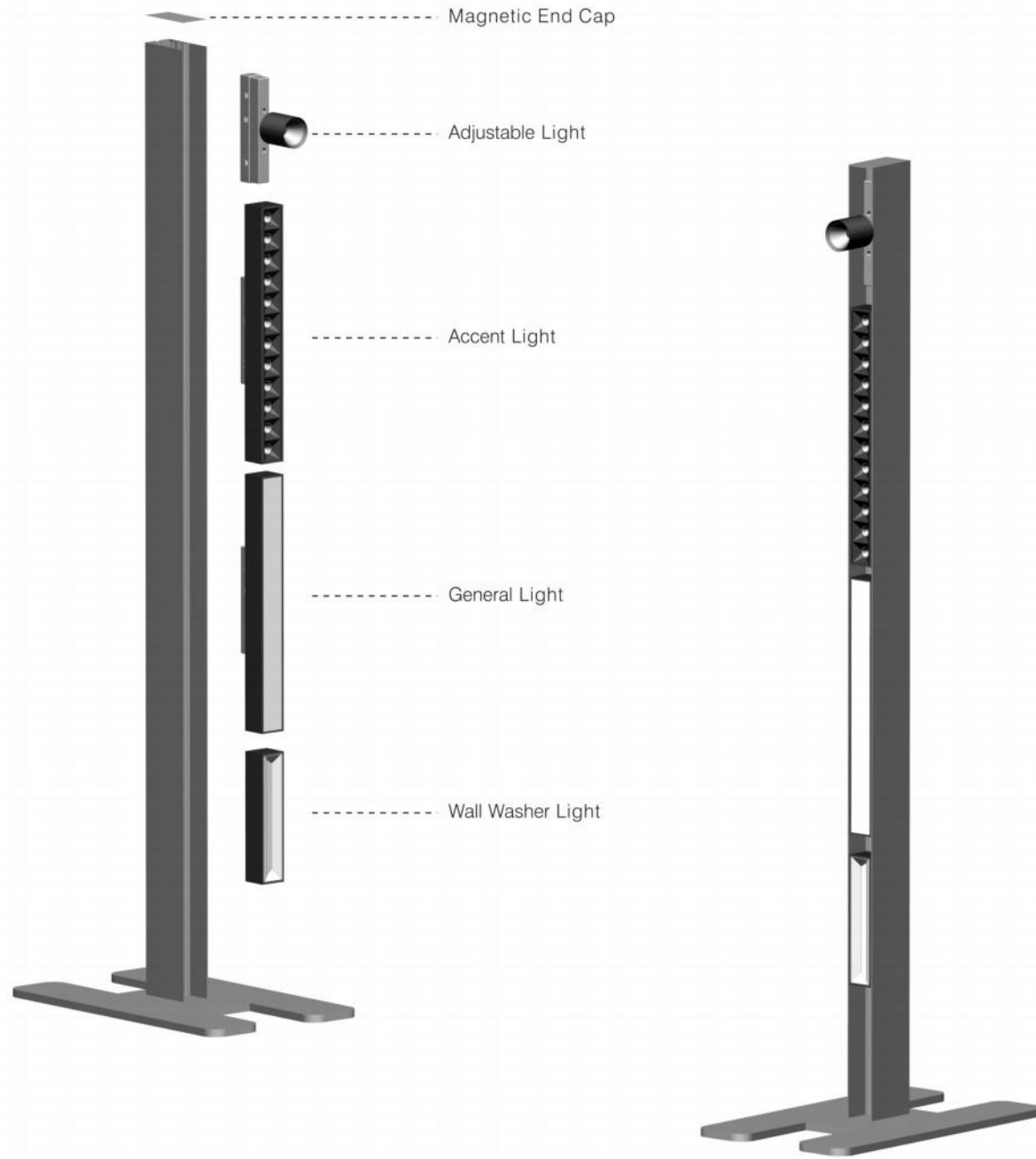

**L TYPE Office Floor System**  
Combo pack

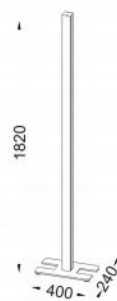

**CBF-1800-W/B/S**  
Body: aluminium  
Housing: aluminium  
Weight: 8.2kg  
CTN: 1PCS

**Assembly Parts**



ITEM:LS  
NUMBER:1PCS



ITEM:  
BAG

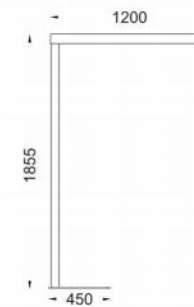

**CBL-1800-W/B/S**  
Body: aluminium  
Housing: aluminium  
Weight: 11.2kg  
CTN: 1PCS

**Assembly Parts**

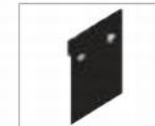

ITEM:LS  
NUMBER:2PCS



ITEM:  
BAG



**Professional linear combination lighting:**

Linear wall washing illumination realizes modular design of products, transcends traditional lighting restriction and installation mode, and realizes freedom of modern design.  
Installation freedom, application freedom, achieve any combination of specifications.

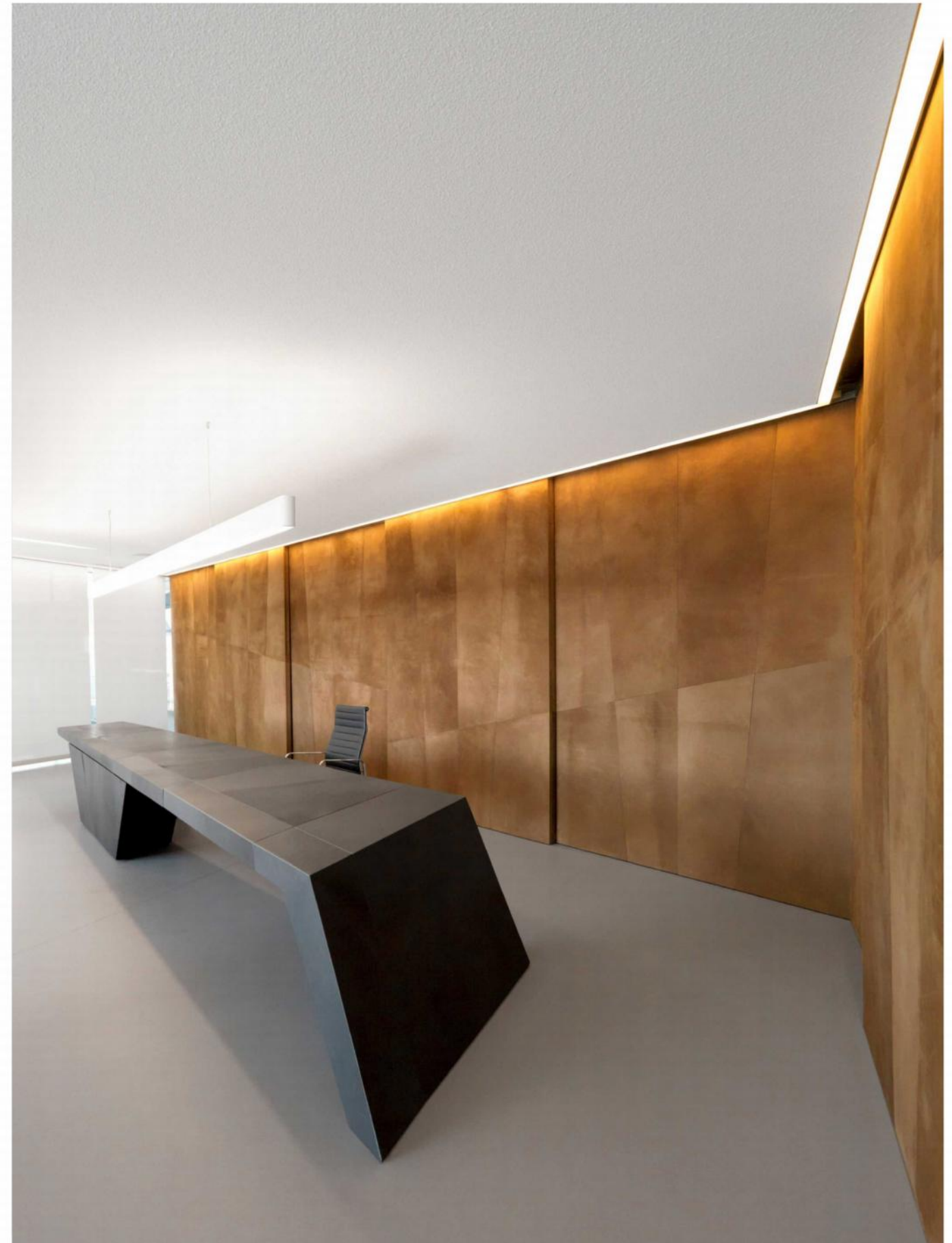
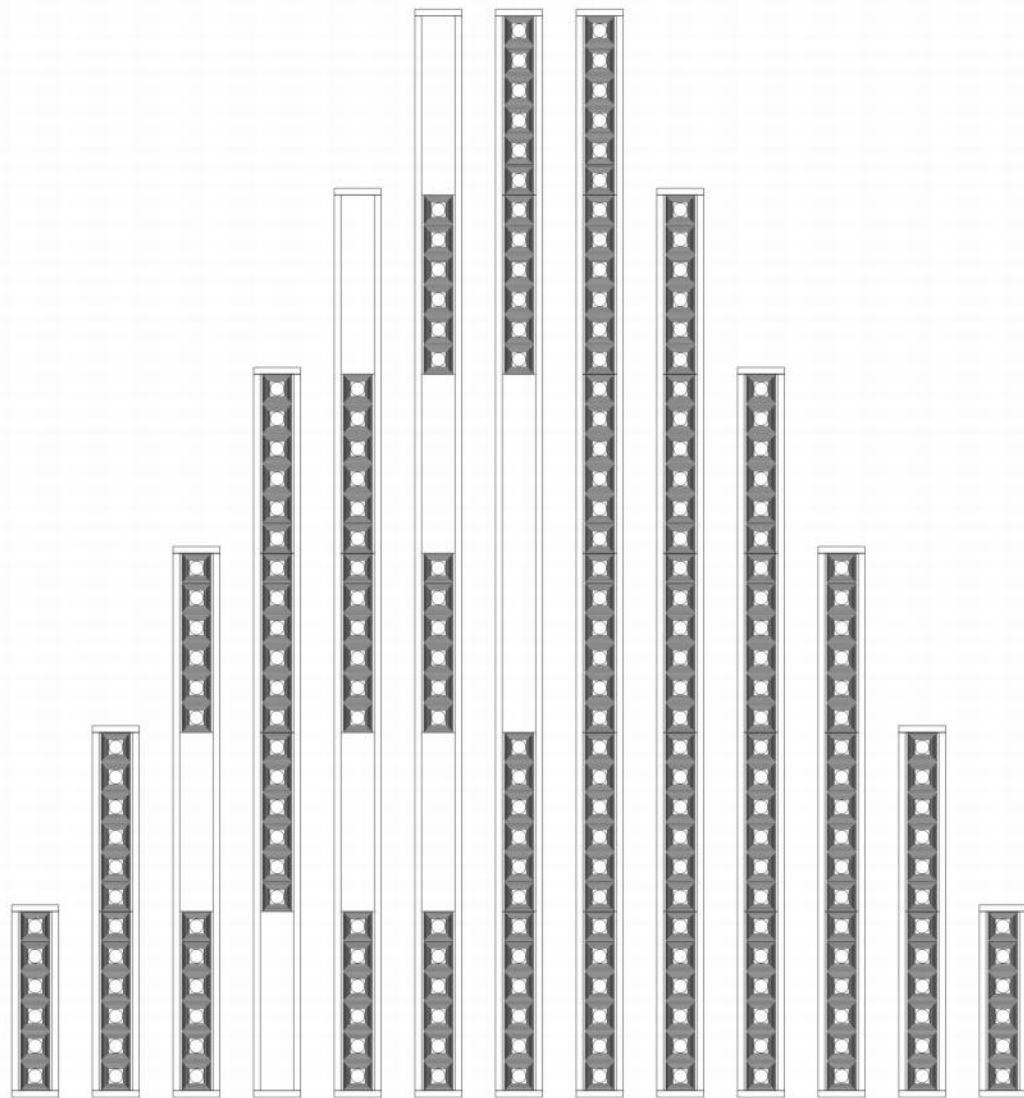



## MAGNETO DC48V SYSTEM

General Light

Accent Light

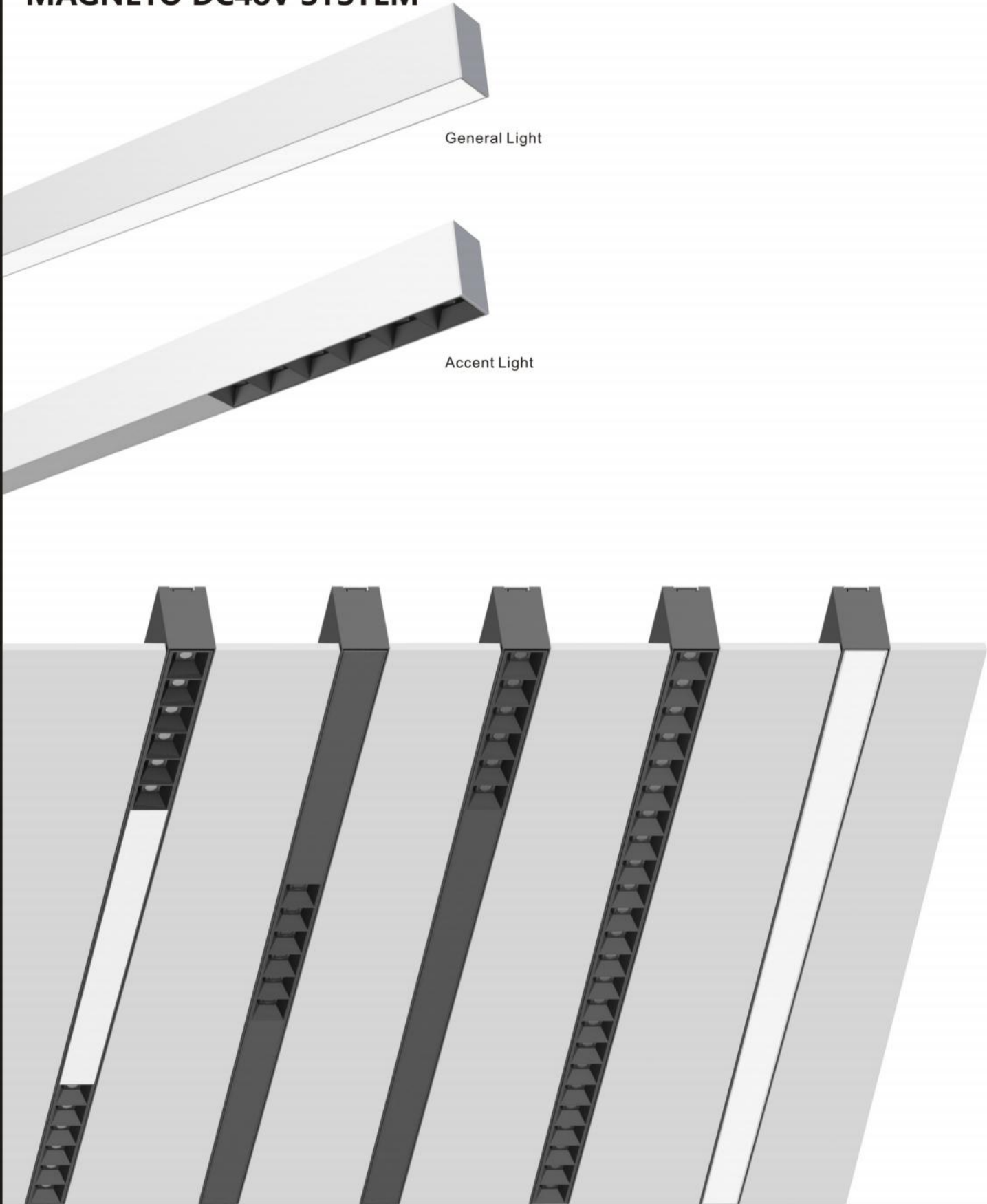

## 48V Fixture Adapter Integrated Driver



ITEM NO.	Driver control	Input current (V)	Output current (mA)
CLX-DC48-SY-01	ON/OFF	DC48V	150mA-600mA
CLX-DC48-SY-02	Bluetooth	DC48V	150mA-600mA
CLX-DC48-SY-03	Dali	DC48V	150mA-450mA



### ON/OFF

This power supply is specially designed for DC-DC custom power supply, input DC power supply output DC power supply, output efficiency, high voltage stabilization accuracy, low ripple noise. With a variety of protection circuits: short circuit protection, low standby power consumption, wide operating temperature range, high reliability, compact structure, light weight and so on.

Power (W)	Output voltage (V)	Output current (mA)	1	2
6	+36V	150mA	x	x
12	+36V	300mA	√	x
18	+36V	450mA	x	√
24	+36V	600mA	√	√

### Casambi / Bluetooth

Power (W)	Output voltage (V)	Output current (mA)	1	2
6	+36V	150mA	x	x
12	+36V	300mA	√	x
18	+36V	450mA	x	√
24	+36V	600mA	√	√

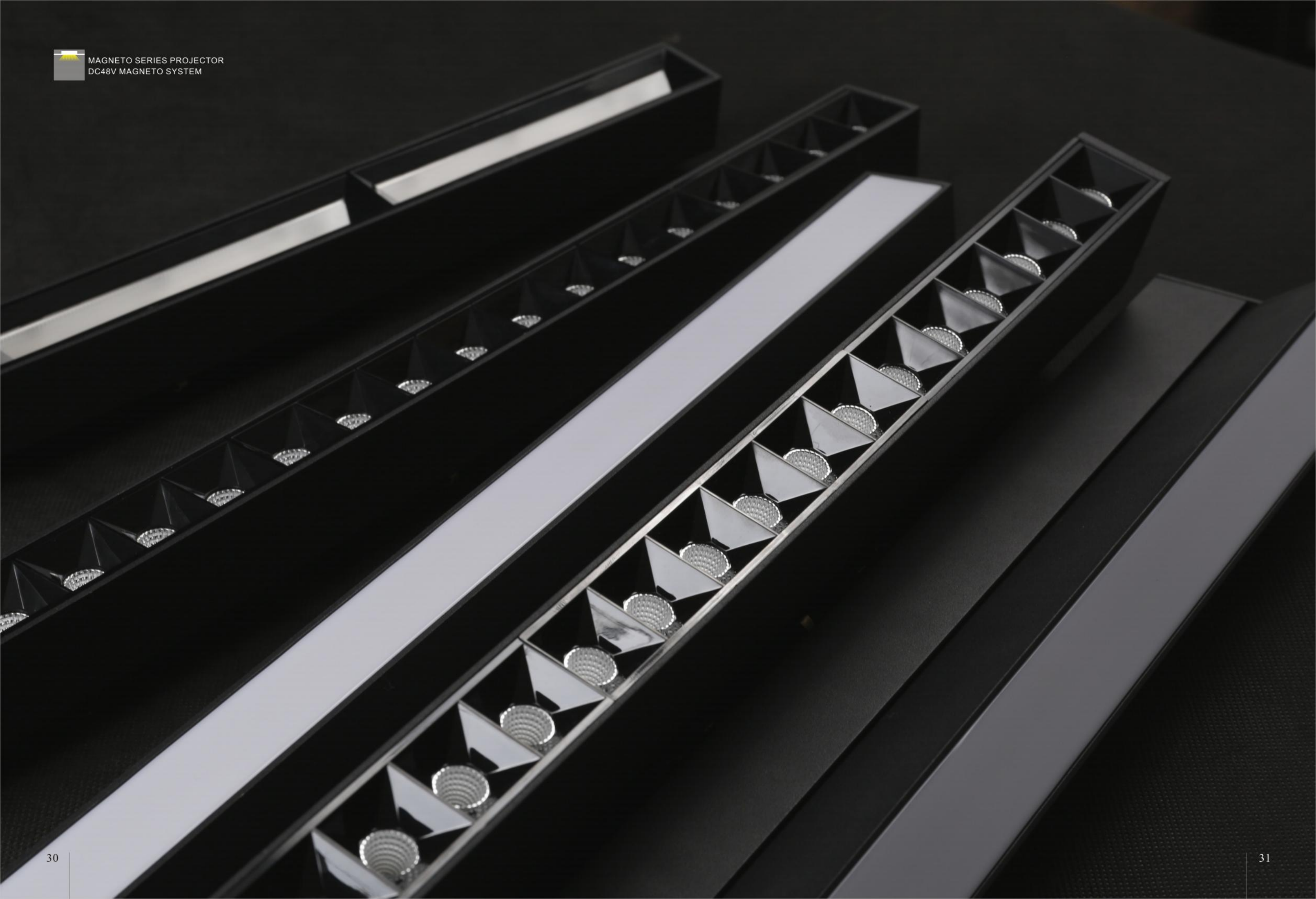





MAGNETO CUBE SERIES FIXED PROJECTOR  
DC48V MAGNETO SYSTEM

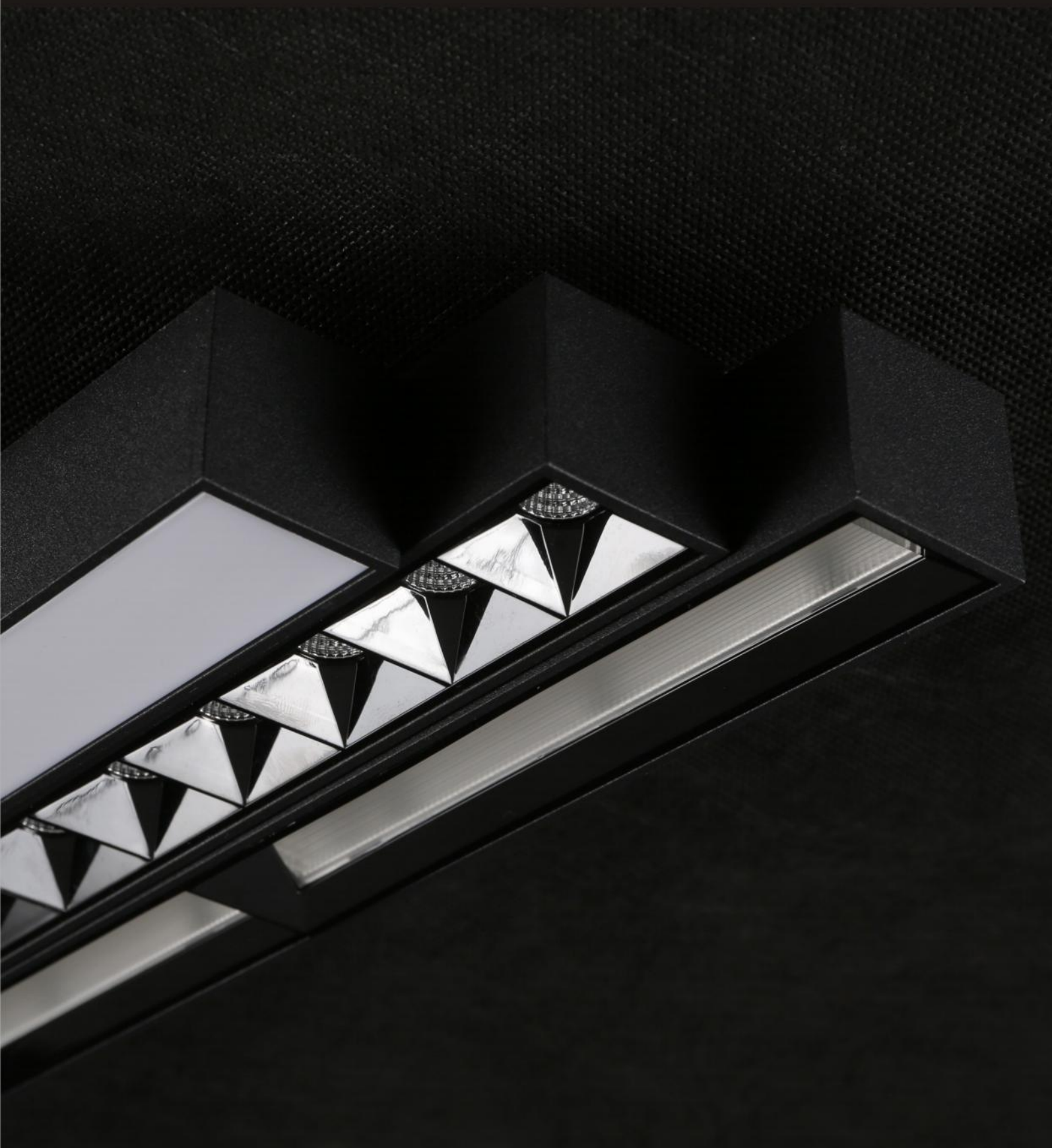

MAGNETO CUBE SERIES FIXED PROJECTOR  
DC48V MAGNETO SYSTEM

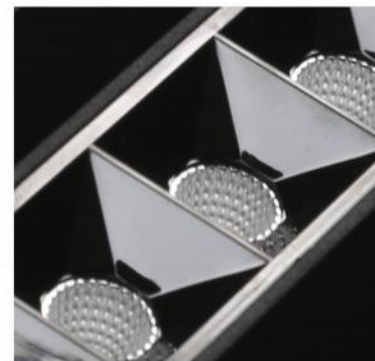

IP20 | CE | CB | | |

Body: aluminium  
Housing: aluminium  
Optic: High efficiency Reflector



Black  
 White

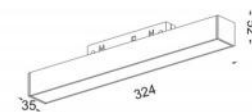

Weight: 0.41kg  
CTN: 30PCS

ORDERING CODE	Power (W)	Beam Angle (°)	CCT (K)	Lumen Packing (Lm)	LOR (%)	UGR	CRI	On/Off	DRIVER Bluetooth	Dali
CB120X-B/W-930 CB120X-B/W-940	12	20/32/48	3000 4000	1310 1340	85%	<19	>90	✓		
CB121X-B/W-930 CB121X-B/W-940	12	20/32/48	3000 4000	1310 1340	85%	<19	>90		✓	
CB122X-B/W-930 CB122X-B/W-940	12	20/32/48	3000 4000	1310 1340	85%	<19	>90			✓

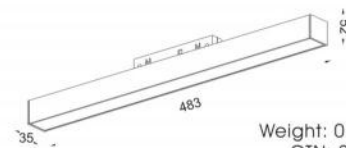

Weight: 0.58kg  
CTN: 20PCS

ORDERING CODE	Power (W)	Beam Angle (°)	CCT (K)	Lumen Packing (Lm)	LOR (%)	UGR	CRI	On/Off	DRIVER Bluetooth	Dali
CB180X-B/W-930 CB180X-B/W-940	18	20/32/48	3000 4000	1965 1980	85%	<19	>90	✓		
CB181X-B/W-930 CB181X-B/W-940	18	20/32/48	3000 4000	1965 1980	85%	<19	>90		✓	
CB182X-B/W-930 CB182X-B/W-940	18	20/32/48	3000 4000	1965 1980	85%	<19	>90			✓

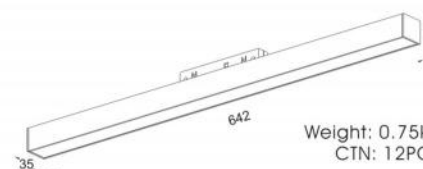

Weight: 0.75kg  
CTN: 12PCS

ORDERING CODE	Power (W)	Beam Angle (°)	CCT (K)	Lumen Packing (Lm)	LOR (%)	UGR	CRI	On/Off	DRIVER Bluetooth	Dali
CB240X-B/W-930 CB240X-B/W-940	24	20/32/48	3000 4000	2620 2680	85%	<19	>90	✓		
CB241X-B/W-930 CB241X-B/W-940	24	20/32/48	3000 4000	2620 2680	85%	<19	>90		✓	
CB242X-B/W-930 CB242X-B/W-940	24	20/32/48	3000 4000	2620 2680	85%	<19	>90			✓



PCB SMD 3030

24W 3000K

PCB SMD 3030			24W 3000K		
h(m)	E(lx)	D(mm)	h(m)	E(lx)	D(mm)
1.0	10659	320	1.0	5096	590
2.0	2664	650	2.0	1274	1170
3.0	1184	970	3.0	566	1760





IP20 | CE | CB | | |

Body: aluminium  
Housing: aluminium  
Optic: PC Diffuser

Black  
 White

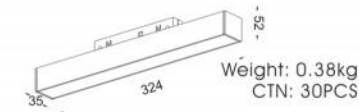

ORDERING CODE	Power (W)	Beam Angle (°)	CCT (K)	Lumen Packing (Lm)	LOR (%)	UGR	CRI	On/Off	DRIVER Bluetooth	Dali
CL1200-B/W-930	12	110	3000	1390	60%	<19	>90	✓		
CL1200-B/W-940			4000	1430						
CL1210-B/W-930	12	110	3000	1390	60%	<19	>90		✓	
CL1210-B/W-940			4000	1430						
CL1220-B/W-930	12	110	3000	1390	60%	<19	>90			✓
CL1220-B/W-940			4000	1430						

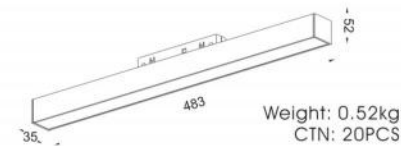

ORDERING CODE	Power (W)	Beam Angle (°)	CCT (K)	Lumen Packing (Lm)	LOR (%)	UGR	CRI	On/Off	DRIVER Bluetooth	Dali
CL1800-B/W-930	18	110	3000	2230	60%	<19	>90	✓		
CL1800-B/W-940			4000	2260						
CL1810-B/W-930	18	110	3000	2230	60%	<19	>90		✓	
CL1810-B/W-940			4000	2260						
CL1820-B/W-930	18	110	3000	2230	60%	<19	>90			✓
CL1820-B/W-940			4000	2260						

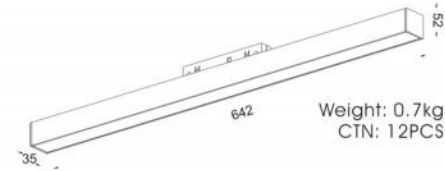

ORDERING CODE	Power (W)	Beam Angle (°)	CCT (K)	Lumen Packing (Lm)	LOR (%)	UGR	CRI	On/Off	DRIVER Bluetooth	Dali
CL2400-B/W-930	24	110	3000	2725	60%	<19	>90	✓		
CL2400-B/W-940			4000	2760						
CL2410-B/W-930	24	110	3000	2725	60%	<19	>90		✓	
CL2410-B/W-940			4000	2760						
CL2420-B/W-930	24	110	3000	2725	60%	<19	>90			✓
CL2420-B/W-940			4000	2760						

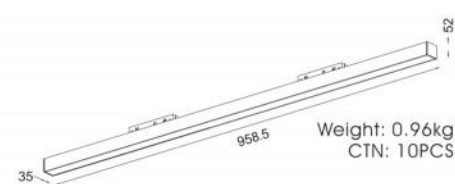

ORDERING CODE	Power (W)	Beam Angle (°)	CCT (K)	Lumen Packing (Lm)	LOR (%)	UGR	CRI	On/Off	DRIVER Bluetooth	Dali
CL4800-B/W-930	48	110	3000	5700	60%	<19	>90	✓		
CL4800-B/W-940			4000	5750						
CL4810-B/W-930	48	110	3000	5700	60%	<19	>90		✓	
CL4810-B/W-940			4000	5750						
CL4820-B/W-930	48	110	3000	5700	60%	<19	>90			✓
CL4820-B/W-940			4000	5750						



PCB SMD 2835    24W 3000K

h(m)	E(lx)	D(mm)
1.0	317	2960
2.0	79	5910
3.0	35	8870









IP20 | CE | CB | | | | |

Body: aluminium  
Housing: aluminium  
Optic: PC Diffuser



Black  
 White

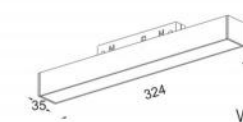

Weight: 0.4kg  
CTN: 30PCS

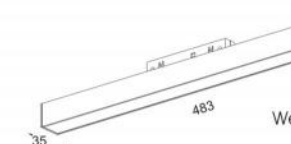

Weight: 0.56kg  
CTN: 20PCS

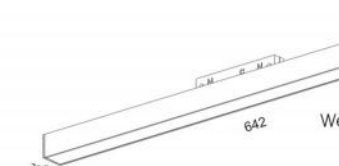

Weight: 0.73kg  
CTN: 12PCS

ORDERING CODE	Power (W)	Beam Angle (°)	CCT (K)	Lumen Packing (Lm)	LOR (%)	UGR	CRI	On/Off	DRIVER Bluetooth	Dali
CW1200-B/W-930	12	54X69	3000	1390	75%	<19	>90	✓		
CW1200-B/W-940			4000	1420						
CW1210-B/W-930	12	54X69	3000	1390	75%	<19	>90		✓	
CW1210-B/W-940			4000	1420						
CW1220-B/W-930	12	54X69	3000	1390	75%	<19	>90			✓
CW1220-B/W-940			4000	1420						

ORDERING CODE	Power (W)	Beam Angle (°)	CCT (K)	Lumen Packing (Lm)	LOR (%)	UGR	CRI	On/Off	DRIVER Bluetooth	Dali
CW1800-B/W-930	18	48X92	3000	2095	75%	<19	>90	✓		
CW1800-B/W-940			4000	2115						
CW1810-B/W-930	18	48X92	3000	2095	75%	<19	>90		✓	
CW1810-B/W-940			4000	2115						
CW1820-B/W-930	18	48X92	3000	2095	75%	<19	>90			✓
CW1820-B/W-940			4000	2115						

ORDERING CODE	Power (W)	Beam Angle (°)	CCT (K)	Lumen Packing (Lm)	LOR (%)	UGR	CRI	On/Off	DRIVER Bluetooth	Dali
CW2400-B/W-930	24	51X71	3000	2780	75%	<19	>90	✓		
CW2400-B/W-940			4000	2820						
CW2410-B/W-930	24	51X71	3000	2780	75%	<19	>90		✓	
CW2410-B/W-940			4000	2820						
CW2420-B/W-930	24	51X71	3000	2780	75%	<19	>90			✓
CW2420-B/W-940			4000	2820						



PCB SMD 2835      24W 3000K

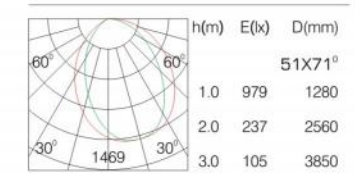



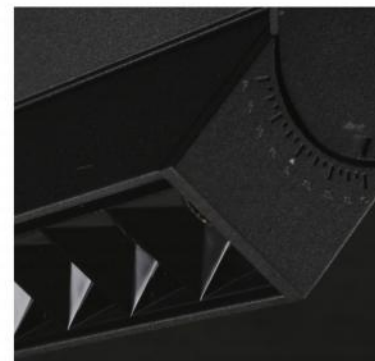

IP20 | CE | CB | | |

Body: aluminium  
Housing: aluminium  
Optic: High efficiency Reflector

Black White

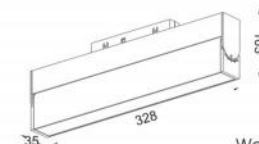

Weight: 0.6kg  
CTN: 18PCS

ORDERING CODE	Power (W)	Beam Angle (°)	CCT (K)	Lumen Packing (Lm)	LOR (%)	UGR	CRI	On/Off	DRIVER Bluetooth	Dali
CA120X-B/W-930	12	20/32/48	3000	1310	85%	<19	>90	✓		
CA120X-B/W-940			4000	1340						
CA121X-B/W-930	12	20/32/48	3000	1310	85%	<19	>90		✓	
CA121X-B/W-940			4000	1340						
CA122X-B/W-930	12	20/32/48	3000	1310	85%	<19	>90			✓
CA122X-B/W-940			4000	1340						

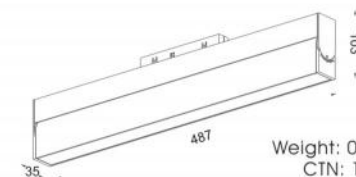

Weight: 0.85kg  
CTN: 15PCS

ORDERING CODE	Power (W)	Beam Angle (°)	CCT (K)	Lumen Packing (Lm)	LOR (%)	UGR	CRI	On/Off	DRIVER Bluetooth	Dali
CA180X-B/W-930	18	20/32/48	3000	1965	85%	<19	>90	✓		
CA180X-B/W-940			4000	1980						
CA181X-B/W-930	18	20/32/48	3000	1965	85%	<19	>90		✓	
CA181X-B/W-940			4000	1980						
CA182X-B/W-930	18	20/32/48	3000	1965	85%	<19	>90			✓
CA182X-B/W-940			4000	1980						

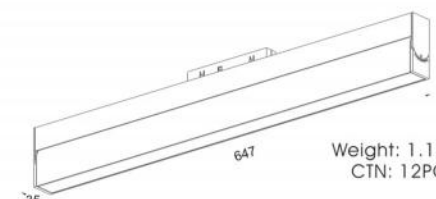

Weight: 1.1kg  
CTN: 12PCS

ORDERING CODE	Power (W)	Beam Angle (°)	CCT (K)	Lumen Packing (Lm)	LOR (%)	UGR	CRI	On/Off	DRIVER Bluetooth	Dali
CA240X-B/W-930	24	20/32/48	3000	2620	85%	<19	>90	✓		
CA240X-B/W-940			4000	2680						
CA241X-B/W-930	24	20/32/48	3000	2620	85%	<19	>90		✓	
CA241X-B/W-940			4000	2680						
CA242X-B/W-930	24	20/32/48	3000	2620	85%	<19	>90			✓
CA242X-B/W-940			4000	2680						



PCB SMD 3030 24W 3000K

PCB SMD 3030			24W 3000K		
h(m)	E(lx)	D(mm)	h(m)	E(lx)	D(mm)
1.0	10659	320	1.0	5096	320
2.0	2664	650	2.0	1274	650
3.0	1184	970	3.0	566	970



IP20 | CE | CB | | |

Body: aluminium  
Housing: aluminium  
Optic: PC Diffuser

Black  
 White

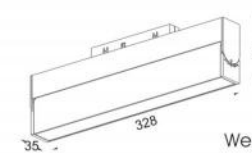

Weight: 0.58kg  
CTN: 18PCS

ORDERING CODE	Power (W)	Beam Angle (°)	CCT (K)	Lumen Packing (Lm)	LOR (%)	UGR	CRI	On/Off	DRIVER Bluetooth	Dali
LA1200-B/W-930	12	110	3000	1390	60%	<19	>90	✓		
LA1200-B/W-940			4000	1430						
LA1210-B/W-930	12	110	3000	1390	60%	<19	>90		✓	
LA1210-B/W-940			4000	1430						
LA1220-B/W-930	12	110	3000	1390	60%	<19	>90			✓
LA1220-B/W-940			4000	1430						

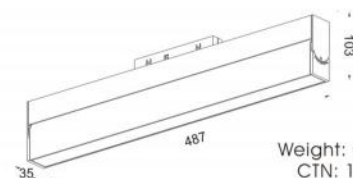

Weight: 0.8kg  
CTN: 15PCS

ORDERING CODE	Power (W)	Beam Angle (°)	CCT (K)	Lumen Packing (Lm)	LOR (%)	UGR	CRI	On/Off	DRIVER Bluetooth	Dali
LA1800-B/W-930	18	110	3000	2230	60%	<19	>90	✓		
LA1800-B/W-940			4000	2260						
LA1810-B/W-930	18	110	3000	2230	60%	<19	>90		✓	
LA1810-B/W-940			4000	2260						
LA1820-B/W-930	18	110	3000	2230	60%	<19	>90			✓
LA1820-B/W-940			4000	2260						

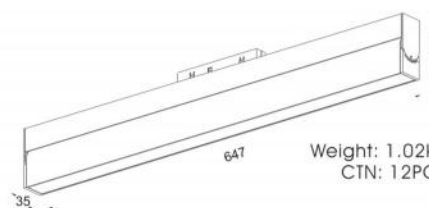

Weight: 1.02kg  
CTN: 12PCS

ORDERING CODE	Power (W)	Beam Angle (°)	CCT (K)	Lumen Packing (Lm)	LOR (%)	UGR	CRI	On/Off	DRIVER Bluetooth	Dali
LA2400-B/W-930	24	110	3000	2725	60%	<19	>90	✓		
LA2400-B/W-940			4000	2760						
LA2410-B/W-930	24	110	3000	2725	60%	<19	>90		✓	
LA2410-B/W-940			4000	2760						
LA2420-B/W-930	24	110	3000	2725	60%	<19	>90			✓
LA2420-B/W-940			4000	2760						



PCB SMD 2835      24W 3000K

	h(m)	E(lx)	D(mm)
60°			110°
1.0	317	2960	
2.0	79	5910	
3.0	35	8870	
30°			317





MAGNETO COBRA WALL WASHER SERIES ADJUSTABLE PROJECTOR  
DC48V MAGNETO SYSTEM



MAGNETO COBRA WALL WASHER SERIES ADJUSTABLE PROJECTOR  
DC48V MAGNETO SYSTEM



IP20 | CE | CB | | |

Body: aluminium  
Housing: aluminium  
Optic: PC Reflector

Black  
 White

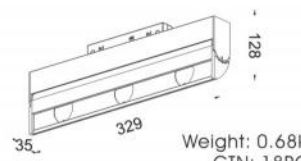

Weight: 0.68kg  
CTN: 18PCS

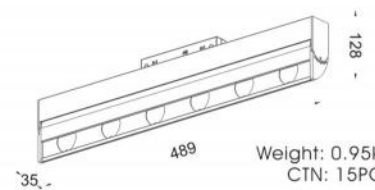

Weight: 0.95kg  
CTN: 15PCS

ORDERING CODE	Power (W)	Beam Angle (°)	CCT (K)	Lumen Packing (Lm)	LOR (%)	UGR	CRI	On/Off	DRIVER Bluetooth	Dali
<b>W1200-B/W-930</b>	12	16X77	3000	1250	65%	<19	>90	✓		
<b>W1200-B/W-940</b>			4000	1280						
<b>W1210-B/W-930</b>	12	16X77	3000	1250	65%	<19	>90		✓	
<b>W1210-B/W-940</b>			4000	1280						
<b>W1220-B/W-930</b>	12	16X77	3000	1250	65%	<19	>90			✓
<b>W1220-B/W-940</b>			4000	1280						

ORDERING CODE	Power (W)	Beam Angle (°)	CCT (K)	Lumen Packing (Lm)	LOR (%)	UGR	CRI	On/Off	DRIVER Bluetooth	Dali
<b>W2400-B/W-930</b>	24	36X68	3000	2180	65%	<19	>90	✓		
<b>W2400-B/W-940</b>			4000	2200						
<b>W2410-B/W-930</b>	24	36X68	3000	2180	65%	<19	>90		✓	
<b>W2410-B/W-940</b>			4000	2200						
<b>W2420-B/W-930</b>	24	36X68	3000	2180	65%	<19	>90			✓
<b>W2420-B/W-940</b>			4000	2200						



PCB SMD 5050 12W 3000K

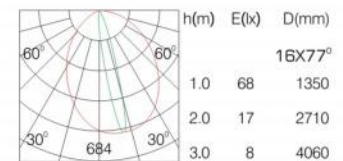

PCB SMD 5050 24W 3000K

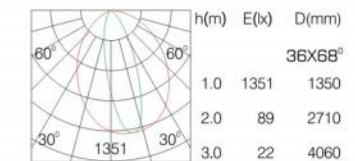



IP20 | CE | CB |

Body: aluminium  
Housing: aluminium  
Optic: High efficiency Reflector

Black  
 White

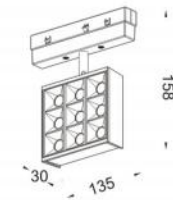

Weight: 0.26kg  
CTN: 36PCS

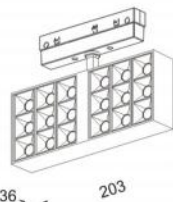

Weight: 0.6kg  
CTN: 18PCS

ORDERING CODE	Power (W)	Beam Angle (°)	CCT (K)	Lumen Packing (Lm)	LOR (%)	UGR	CRI	DRIVER On/Off	Bluetooth	Dali
CS90X-B/W-930	12	10/40/50	3000	1280	85%	<19	>90	✓		
CS90X-B/W-940			4000	1300						
CS91X-B/W-930	12	10/40/50	3000	1280	85%	<19	>90		✓	
CS91X-B/W-940			4000	1300						
CS92X-B/W-930	12	10/40/50	3000	1280	85%	<19	>90			✓
CS92X-B/W-940			4000	1300						

ORDERING CODE	Power (W)	Beam Angle (°)	CCT (K)	Lumen Packing (Lm)	LOR (%)	UGR	CRI	DRIVER On/Off	Bluetooth	Dali
CS180X-B/W-930	18	10/40/50	3000	1880	85%	<19	>90	✓		
CS180X-B/W-940			4000	1920						
CS181X-B/W-930	18	10/40/50	3000	1880	85%	<19	>90		✓	
CS181X-B/W-940			4000	1920						
CS182X-B/W-930	18	10/40/50	3000	1880	85%	<19	>90			✓
CS182X-B/W-940			4000	1920						



PCB SMD 3030

18W 3000K

10°			40°			50°		
h(m)	E(lx)	D(mm)	h(m)	E(lx)	D(mm)	h(m)	E(lx)	D(mm)
1.0	21528	170	1.0	2381	770	1.0	1922	940
2.0	5382	330	2.0	595	1530	2.0	480	1880
3.0	2392	500	3.0	264	2300	3.0	213	2820





MAGNETO CUBE SERIES ADJUSTABLE PROJECTOR  
DC48V MAGNETO SYSTEM



MAGNETO CUBE SERIES ADJUSTABLE PROJECTOR  
DC48V MAGNETO SYSTEM







MAGNETO MICRO SERIES ADJUSTABLE PROJECTOR  
DC48V MAGNETO SYSTEM

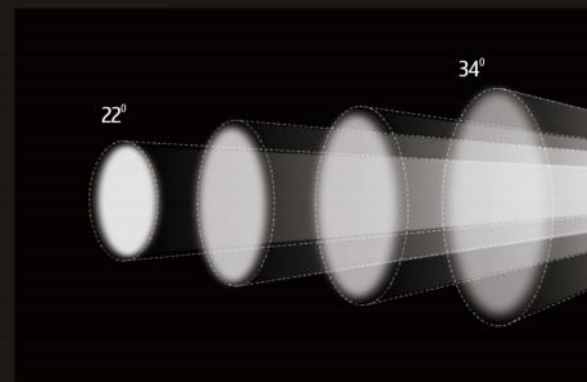
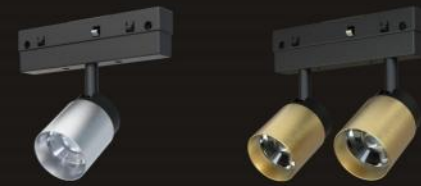

MAGNETO MICRO SERIES ADJUSTABLE PROJECTOR  
DC48V MAGNETO SYSTEM



IP20 | CE | CB | | |

Body: aluminium  
Housing: aluminium  
Optic: High efficiency Lens

Black White Brushed brass Brushed aluminium

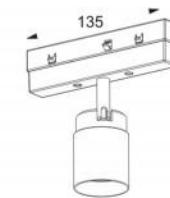

Weight: 0.23kg  
CTN: 36PCS

ORDERING CODE	Power (W)	Beam Angle (°)	CCT (K)	Lumen Packing (Lm)	LOR (%)	UGR	CRI	DRIVER	Dali
<b>\$1000-B/W-930</b>	6	22-34	3000	610	70%	<19	>90	On/Off	✓
<b>\$1000-B/W-940</b>			4000	625	<19	>90	Bluetooth		
<b>\$1010-B/W-930</b>	6	22-34	3000	610	70%	<19	>90		✓
<b>\$1010-B/W-940</b>			4000	625	<19	>90	Bluetooth		
<b>\$1020-B/W-930</b>	6	22-34	3000	610	70%	<19	>90		✓
<b>\$1020-B/W-940</b>			4000	625	<19	>90	Bluetooth		

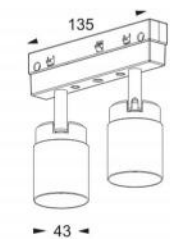

Weight: 0.4kg  
CTN: 36PCS

ORDERING CODE	Power (W)	Beam Angle (°)	CCT (K)	Lumen Packing (Lm)	LOR (%)	UGR	CRI	DRIVER	Dali
<b>\$2000-B/W-930</b>	6*2	22-34	3000	1180	70%	<19	>90	On/Off	✓
<b>\$2000-B/W-940</b>			4000	1200	<19	>90	Bluetooth		
<b>\$2010-B/W-930</b>	6*2	22-34	3000	1180	70%	<19	>90		✓
<b>\$2010-B/W-940</b>			4000	1200	<19	>90	Bluetooth		
<b>\$2020-B/W-930</b>	6*2	22-34	3000	1180	70%	<19	>90		✓
<b>\$2020-B/W-940</b>			4000	1200	<19	>90	Bluetooth		

0 ON/OFF 1 Bluetooth 2 Dali

13.5x13.5mm COB

6W 3000K

22°			34°		
h(m)	E(lx)	D(mm)	h(m)	E(lx)	D(mm)
1.0	1656	430	1.0	1089	430
2.0	414	860	2.0	270	860
3.0	184	1290	3.0	120	1290





IP20 | CE | CB | | |

Body: Die-Casting Aluminium  
Housing: Die-Casting Aluminium  
Optic: High efficiency Reflector

**105** INTERCHANGIBLE OPTICAL SYSTEM | **108** INTERCHANGIBLE OPTICAL SYSTEM

Black | White

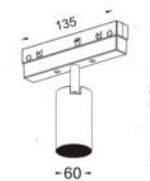

Weight: 0.37kg  
CTN: 20PCS

ORDERING CODE	Power (W)	Beam Angle (°)	CCT (K)	Lumen Packing (Lm)	LOR (%)	UGR	CRI	On/Off	DRIVER Bluetooth	Dali
<b>S180X-B/W-930</b>	12	20/40/55	3000	1440	75%	<19	>90	✓		
<b>S180X-B/W-940</b>			4000	1470						
<b>S181X-B/W-930</b>	12	20/40/55	3000	1440	75%	<19	>90		✓	
<b>S181X-B/W-940</b>			4000	1470						
<b>S182X-B/W-930</b>	12	20/40/55	3000	1440	75%	<19	>90			✓
<b>S182X-B/W-940</b>			4000	1470						



Optical accessories See P.012

COB 1203						3000K					
h(m)	E(lx)	D(mm)	h(m)	E(lx)	D(mm)	h(m)	E(lx)	D(mm)	h(m)	E(lx)	D(mm)
1.0	4036	450	1.0	2720	680	1.0	1865	760	1.0	4036	450
2.0	1009	900	2.0	680	1360	2.0	466	1510	2.0	1009	900
3.0	448	1350	3.0	302	2040	3.0	207	2270	3.0	448	1350



IP20 | CE | CB | | |

Body: aluminium  
Housing: aluminium  
Optic: High efficiency Lens

Black  
 White



Weight: 0.32kg  
CTN: 60PCS

ORDERING CODE	Power (W)	Beam Angle (°)	CCT (K)	Lumen Packing (Lm)	LOR (%)	UGR	CRI	On/Off	DRIVER Bluetooth	Dali
MP4000-B/W-930 MP4000-B/W-940	12	22-34	3000 4000	1180 1200	70%	<19	>90	✓		
MP4010-B/W-930 MP4010-B/W-940	12	22-34	3000 4000	1180 1200	70%	<19	>90		✓	
MP4020-B/W-930 MP4020-B/W-940	12	22-34	3000 4000	1180 1200	70%	<19	>90			✓

0 ON/OFF  
1 Bluetooth  
2 Dali

13.5x13.5mm COB

12W 3000K

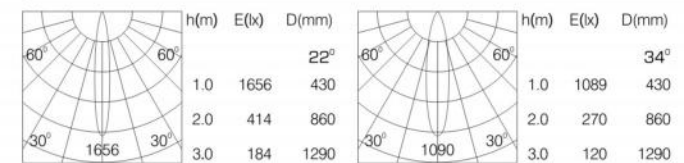

IP20 | CE | CB | | |

Body: aluminium  
Housing: aluminium  
Optic: Glass

White



Weight: 0.4kg  
CTN: 30PCS

ORDERING CODE	Power (W)	Beam Angle (°)	CCT (K)	Lumen Packing (Lm)	LOR (%)	UGR	CRI	On/Off	DRIVER Bluetooth	Dali
MP8000-B/W-930 MP8000-B/W-940	6	270	3000 4000	610 625	70%	<19	>90			
MP8010-B/W-930 MP8010-B/W-940	6	270	3000 4000	610 625	70%	<19	>90			
MP8020-B/W-930 MP8020-B/W-940	6	270	3000 4000	610 625	70%	<19	>90			

0 ON/OFF  
1 Bluetooth  
2 Dali



