

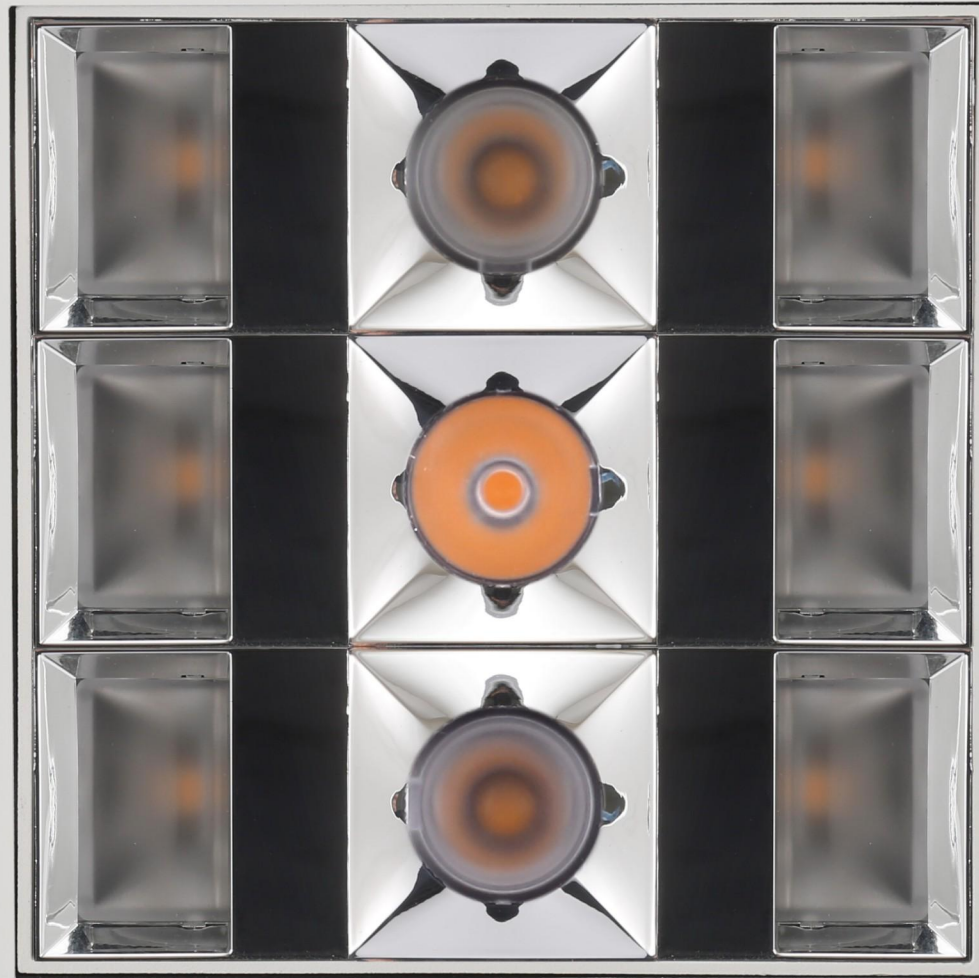

INFINITY SERIES



Product features

INFINITY recessed /surface mount luminaire, set new standards in their category: The high-performance range, consisting of accent, ambience & basic in one lighting fixture. Thanks to smart light technology that make this light totally flexible. INFINITY meets superior standards of visual comfort and efficiency whilst delivering optimal light quality for a multitude of visual tasks. With an emission angle of narrow, flood, square distribution, elliptical & wall washing effect. INFINITY downlights meet the challenges of illumination your application in a new way.

INFINITY Offers total flexibility. Thanks to the special designed Recessed Trim / Trim-Trimless hybrid installation which minimize your stock and keeps your customer to enjoy the freedom of choosing the best application it's needs. The single individual LED module & reflector combine in all kinds of your application really depend on your imagination.

Range of Application

Commercial
Architectural
Museum / Art gallery



General lighting
Emphasis of objects or architectural elements.

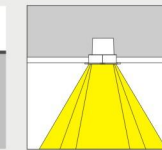

Downlights
Narrow to wide beam, Rotateally symmetrical light distribution for accent lighting.

LED
Wattage:6.5-40W
Lumen:519-3521lm
Light distribution:
Narrow/Medium/Flood



General lighting
Emphasis of Multi objects or architectural elements.

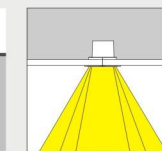
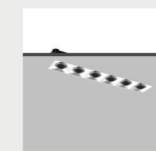

Downlights
Narrow to wide beam, Rotateally symmetrical light distribution for accent lighting.

LED
Wattage:6.5-40W
Lumen:519-3521lm
Light distribution:
Narrow/Medium/Flood



Suitable for indoor use



Protection level is IP20



High efficiency Reflector



Comply with CE certification



The electrical grade is class2



CRI > 80 (standard)
CRI > 90 (optional)

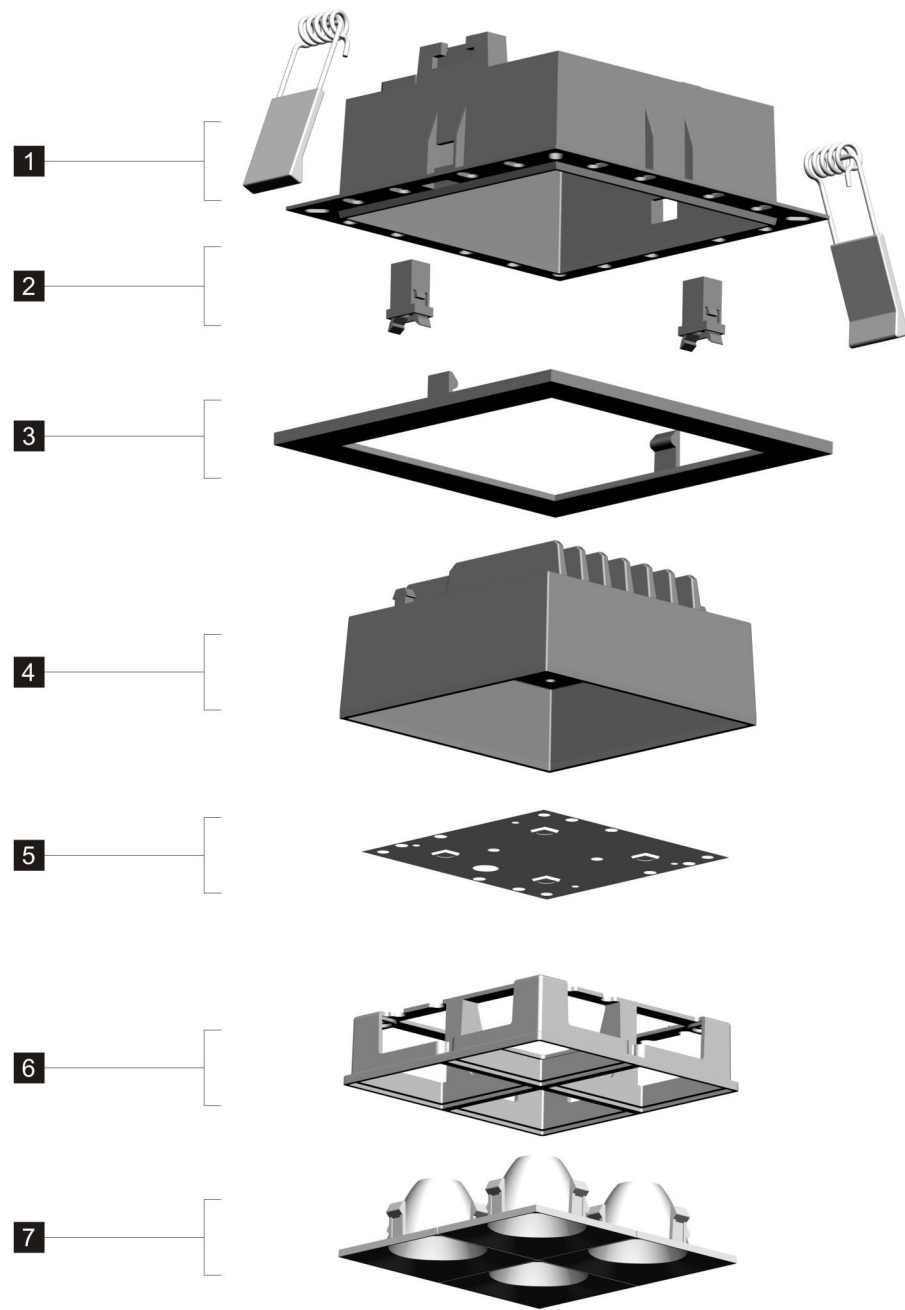

**Exploded
view**

- | | | | |
|---|---|---|---|
| 1 | Hardware embedded parts | 5 | Hardware embedded parts |
| 2 | LED optical module | 6 | LED optical module |
| 3 | Optical accessories (glass, honey comb) | 7 | Optical accessories (glass, honey comb) |
| 4 | Optical accessories (glass, honey comb) | | |

**Reliable ceiling
mounting system**

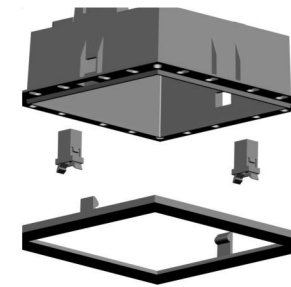

Mounting spring system and integrated clip on the fixture enables secure, one-touch installation, eliminating the need of tighten screws. Best of all the process requires no additional parts, So you don't need to worry about losing anchors or clips.

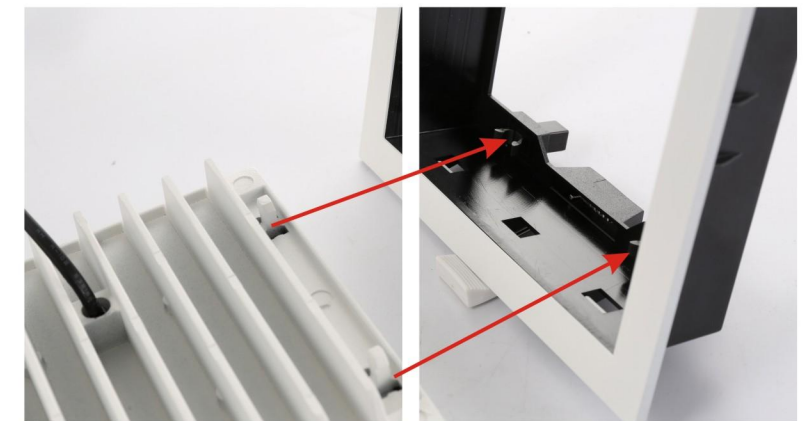

Quick and convenient installation

The buckle structure design can quickly replace the lamp body, and the disassembly and assembly are more convenient. Maintenance is easier.



Quick and convenient installation

Mounting spring system and integrated clip on the fixture enables secure, one-touch installation, eliminating the need of tighten screws. Best of all the process requires no additional parts, So you don't need to worry about losing anchors or clips.

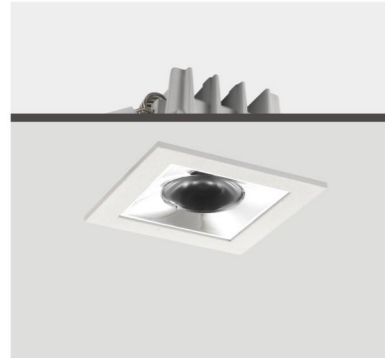

IP20 | CE | CB |

Trim: Die-cast aluminium
Body: Die-cast aluminium
Housing: Die-cast aluminium
Optic: High efficiency Reflector
Weight: 0.06kg
CTN: 80PCS

IO7 INTERCHANGEABLE OPTICAL SYSTEM See P.41

White Black

Note: min 80mm(ceiling clearance)

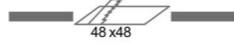

ORDERING CODE	Power (W)	Beam Angle (°)	CCT (K)	Hot Lumen (Lm)	LOR (%)	UGR	On/Off	DRIVER Bluetouch	Zigbee
NFG500-1-W/B-930 NFG500-1-W/B-940	4.2	12	3000 4000	360 368	90%	<19	✓	✓	✓
NFG500-2-W/B-930 NFG500-2-W/B-940	4.2	20	3000 4000	334 340	84%	<19	✓	✓	✓
NFG500-3-W/B-930 NFG500-3-W/B-940	4.2	33	3000 4000	336 340	84%	<19	✓	✓	✓
NFG500-4-W/B-930 NFG500-4-W/B-940	4.2	45	3000 4000	293 300	74%	<19	✓	✓	✓
NFG500-5-W/B-930 NFG500-5-W/B-940	4.2	20-35	3000 4000	322 330	81%	<19	✓	✓	✓
NFG500-6-W/B-930 NFG500-6-W/B-940	4.2	60x60	3000 4000	341 350	85%	<19	✓	✓	✓
NFG500-7-W/B-930 NFG500-7-W/B-940	4.2	60-70	3000 4000	257 265	64%	<19	✓	✓	✓

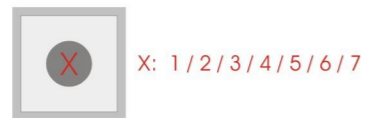

IO7 INTERCHANGEABLE OPTICAL SYSTEM

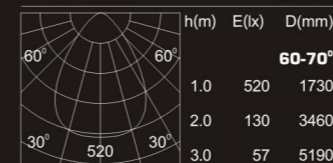
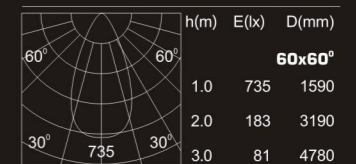
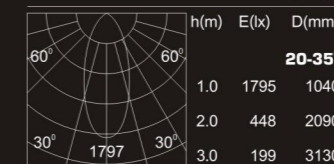
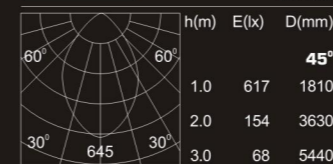
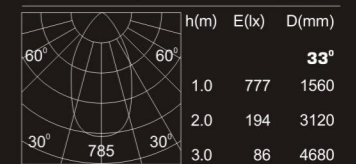
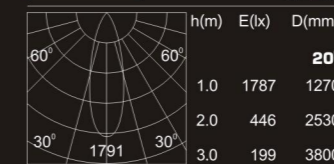
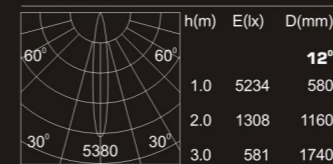

INFINITY SERIES PROJECTOR
LED DOWNLIGHT

70X185



IP20 | CE | CB |

Trim: PC
Body: PC
Housing: Die-cast aluminium
Optic: High efficiency Reflector
Weight: 0.2kg
CTN: 50PCS

IO7 INTERCHANGABLE OPTICAL SYSTEM See P.41

White Black

Note: min 80mm(ceiling clearance)

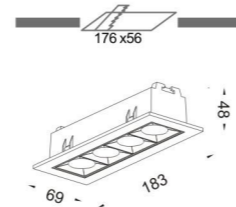

ORDERING CODE	Power (W)	CCT (K)	Hot Lumen (Lm)	LOR (%)	UGR	On/Off	DRIVER Bluetouch	Zigbee
NFG1800-W/B-930 (Without Optics)	15	3000	1243	90%	<19	✓	✓	✓
NFG1800-W/B-940 (Without Optics)	15	4000	1260	90%	<19	✓	✓	✓
NFG1800-W/B-930+A+B+C+D	15	3000	1243	90%	<19	✓	✓	✓
NFG1800-W/B-940+A+B+C+D	15	4000	1260	90%	<19	✓	✓	✓

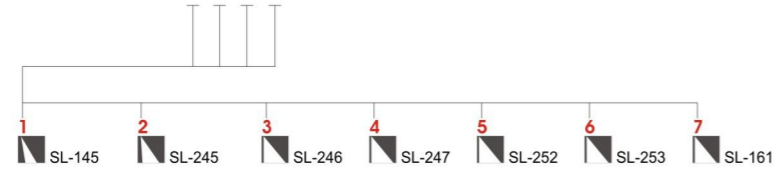

Note: min 80mm(ceiling clearance)

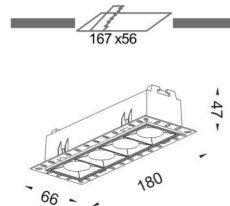

A: 1/2/3/4/5/6/7
B: 1/2/3/4/5/6/7
C: 1/2/3/4/5/6/7
D: 1/2/3/4/5/6/7

INFINITY SERIES PROJECTOR
LED DOWNLIGHT

70x260



IP20 | CE | CB |

Trim: PC
Body: PC
Housing: Die-cast aluminium
Optic: High efficiency Reflector
Weight: 0.32kg
CTN: 25PCS

IO7 INTERCHANGABLE OPTICAL SYSTEM See P.41

White Black

Note: min 80mm(ceiling clearance)

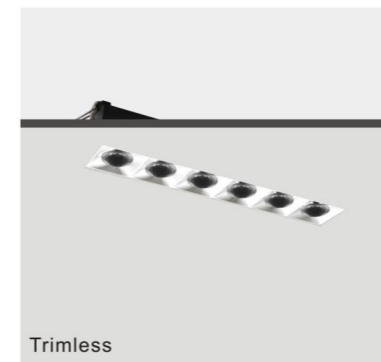
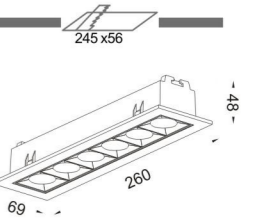

ORDERING CODE	Power (W)	CCT (K)	Hot Lumen (Lm)	LOR (%)	UGR	On/Off	DRIVER Bluetouch	Zigbee
NFG2600-W/B-930 (Without Optics)	28	3000	2165	90%	<19	✓	✓	✓
NFG2600-W/B-940 (Without Optics)	28	4000	2180	90%	<19	✓	✓	✓
NFG2600-W/B-930+A+B+C+D+E+F	28	3000	2165	90%	<19	✓	✓	✓
NFG2600-W/B-940+A+B+C+D+E+F	28	4000	2180	90%	<19	✓	✓	✓

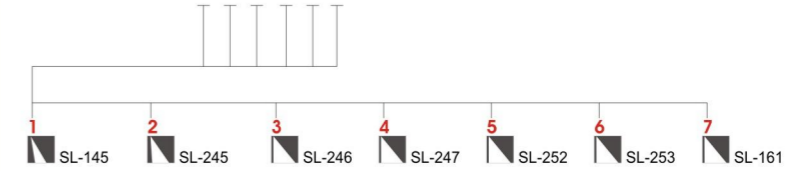

Note: min 80mm(ceiling clearance)

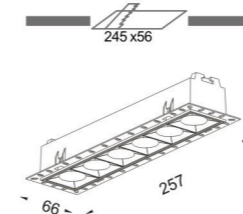

A: 1/2/3/4/5/6/7
B: 1/2/3/4/5/6/7
C: 1/2/3/4/5/6/7
D: 1/2/3/4/5/6/7
E: 1/2/3/4/5/6/7
F: 1/2/3/4/5/6/7

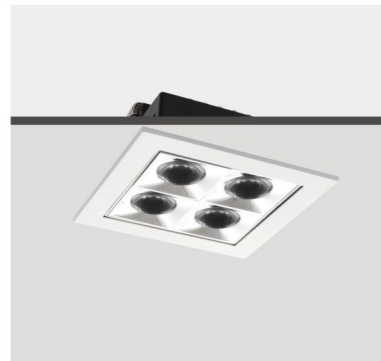

IP20 | CE | CB |

Trim: PC
Body: PC
Housing: Die-cast aluminium
Optic: High efficiency Reflector
Weight: 0.23kg
CTN: 36PCS

107 INTERCHANGEABLE OPTICAL SYSTEM See P.41

White Black

Note: min 80mm(ceiling clearance)

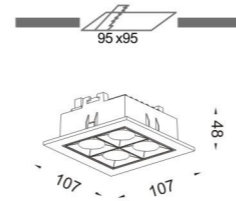

ORDERING CODE	Power (W)	CCT (K)	Hot Lumen (Lm)	LOR (%)	UGR	On/Off	DRIVER Bluetouch	Zigbee
NFG1000-W/B-930 (Without Optics)	15	3000	1243	90%	<19	✓	✓	✓
NFG1000-W/B-940 (Without Optics)	15	4000	1260	90%	<19	✓	✓	✓
NFG1000-W/B-930+A+B+C+D	15	3000	1243	90%	<19	✓	✓	✓
NFG1000-W/B-940+A+B+C+D	15	4000	1260	90%	<19	✓	✓	✓

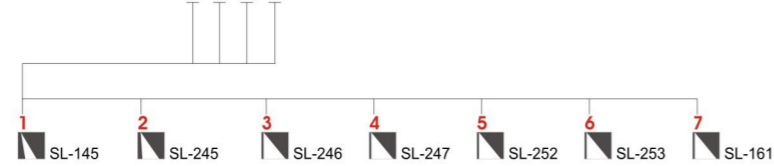

Note: min 80mm(ceiling clearance)

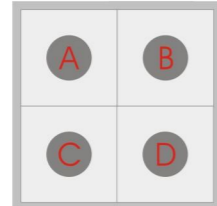
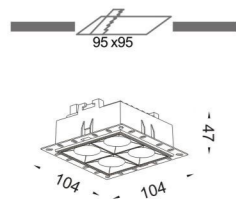

A: 1/2/3/4/5/6/7
B: 1/2/3/4/5/6/7
C: 1/2/3/4/5/6/7
D: 1/2/3/4/5/6/7

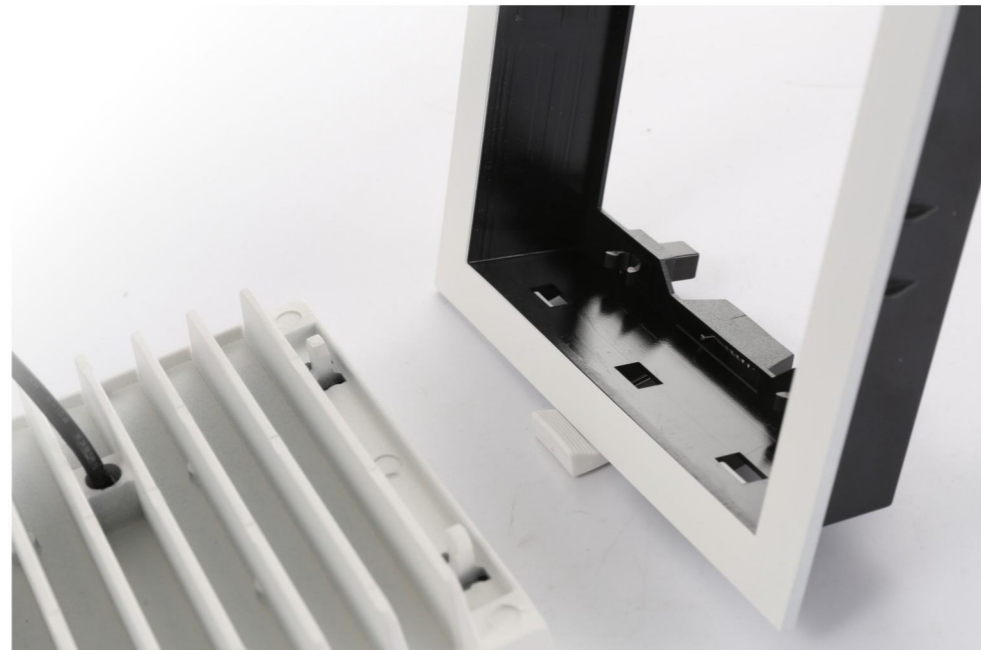

IP20 | CE | CB |

Trim: PC
Body: PC
Housing: Die-cast aluminium
Optic: High efficiency Reflector
Weight: 0.43kg
CTN: 24PCS

107 INTERCHANGEABLE OPTICAL SYSTEM See P.41

White Black

Note: min 80mm(ceiling clearance)

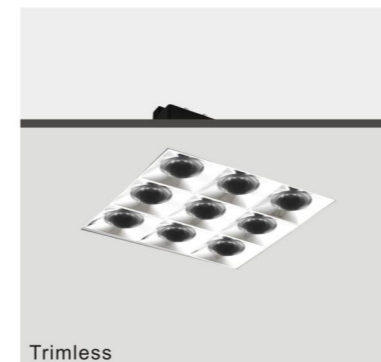
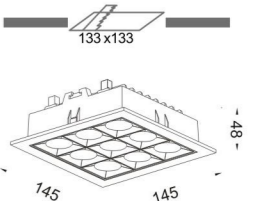

ORDERING CODE	Power (W)	CCT (K)	Hot Lumen (Lm)	LOR (%)	UGR	On/Off	DRIVER Bluetouch	Zigbee
NFG1500-W/B-930 (Without Optics)	32	3000	2928	90%	<19	✓	✓	✓
NFG1500-W/B-940 (Without Optics)	32	4000	2940	90%	<19	✓	✓	✓
NFG1500-W/B-930+A+B+C+D+E+F+G+H+I	32	3000	2928	90%	<19	✓	✓	✓
NFG1500-W/B-940+A+B+C+D+E+F+G+H+I	32	4000	2940	90%	<19	✓	✓	✓



Note: min 80mm(ceiling clearance)

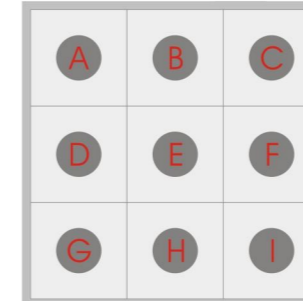
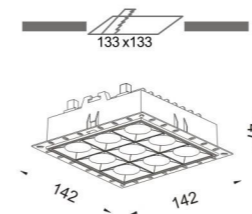

A: 1/2/3/4/5/6/7
B: 1/2/3/4/5/6/7
C: 1/2/3/4/5/6/7
D: 1/2/3/4/5/6/7
E: 1/2/3/4/5/6/7
F: 1/2/3/4/5/6/7
G: 1/2/3/4/5/6/7
H: 1/2/3/4/5/6/7
I: 1/2/3/4/5/6/7

No Frame Ceiling Installtion

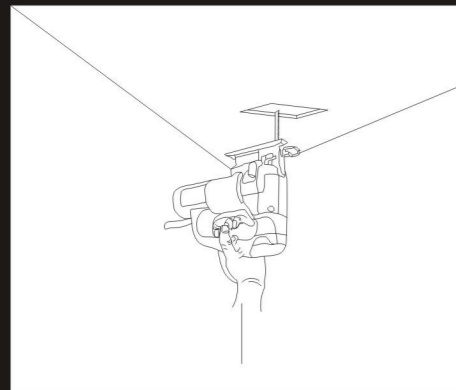

According to the data, open the appropriate mounting holes in the blooming board;

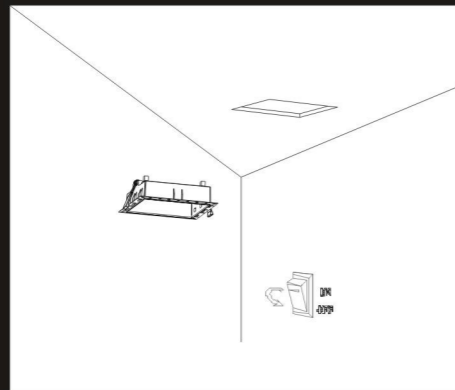

Turn off the power switch;
Measuring the thickness of the ceiling, adjusting the no frame to the appropriate size, and locking the

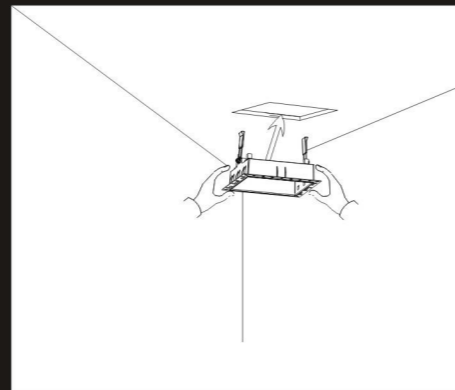

The lamp frame up, into the ceiling;

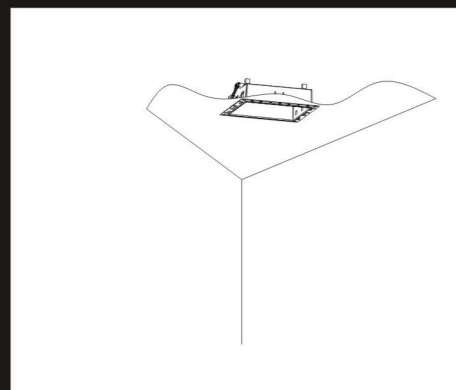

The lamp frame level down, and the center;

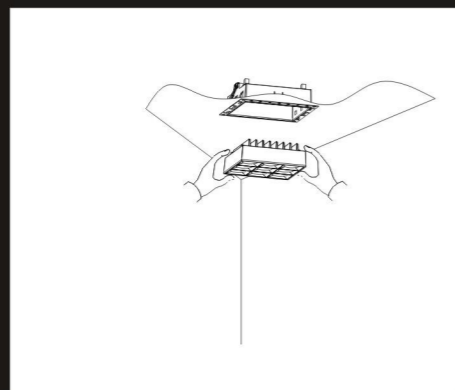

Use the tip of the tail screw in the packing box, the position of the locking plate in the frame;

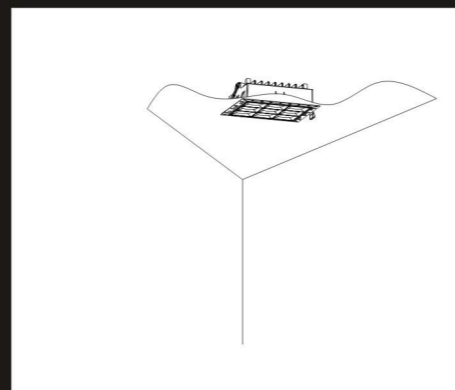

The outer periphery and screw position wall dust disappearing;

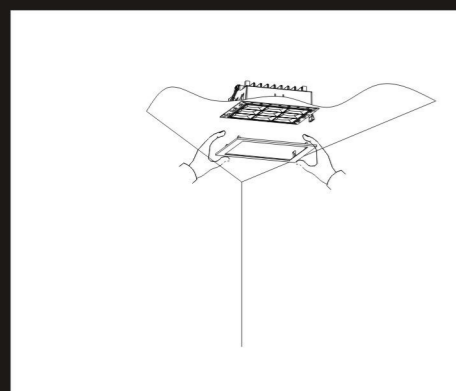

Connect the lamp driver to the end of the line;

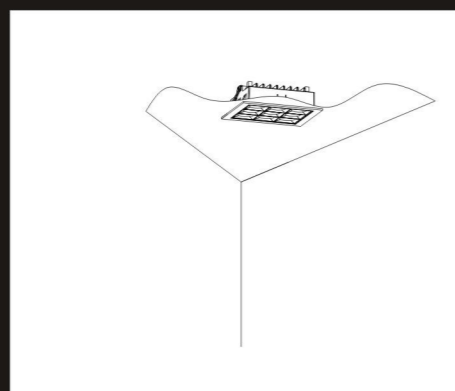

The lamp and drive into the frame, hear "click" sound, see the lamp is stable;

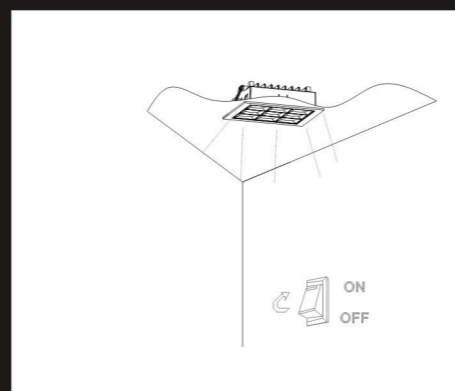

Turn on the power supply and adjust the angle of the normal use of the lamps;



INFINITY SERIES PROJECTOR
LED DOWNLIGHT

70X185



IP20 | CE | CB |

Trim: PC
Body: PC
Housing: Die-cast aluminium
Optic: PC Diffuser
Weight: 0.3kg
CTN: 20PCS

White Black

Note: min 80mm(ceiling clearance)

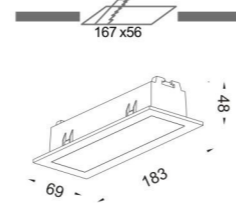

ORDERING CODE	Power (W)	Beam Angle (°)	CCT (K)	Hot Lumen (Lm)	LOR (%)	UGR	On/Off	DRIVER 1-10V	DALI	Triac
NFL1800-W/B/S-830			3000	831						
NFL1800-W/B/S-840	18	117	4000	845	48%	<19	✓	✓	✓	✓
NFL1800-W/B/S-850			5000	860						

OSRAM 2835 3000K

h(m)	E(lx)	D(mm)
		117°
1.0	284	11870
2.0	71	23750
3.0	31	35620

Note: min 80mm(ceiling clearance)

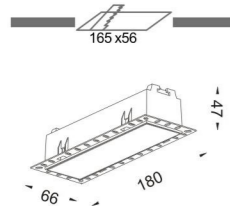

INFINITY SERIES PROJECTOR
LED DOWNLIGHT

70X260



IP20 | CE | CB |

Trim: PC
Body: PC
Housing: Die-cast aluminium
Optic: PC Diffuser
Weight: 0.5kg
CTN: 25PCS

White Black

Note: min 80mm(ceiling clearance)

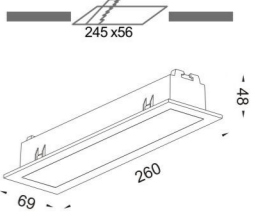

ORDERING CODE	Power (W)	Beam Angle (°)	CCT (K)	Hot Lumen (Lm)	LOR (%)	UGR	On/Off	DRIVER 1-10V	DALI	Triac
NFL2600-W/B/S-830			3000	1330						
NFL2600-W/B/S-840	26	112	4000	1340	48%	<19	✓	✓	✓	✓
NFL2600-W/B/S-850			5000	1355						

OSRAM 2835 3000K

h(m)	E(lx)	D(mm)
		112°
1.0	451	11460
2.0	112	22910
3.0	50	34370

Note: min 80mm(ceiling clearance)

